

ESWEEK Tutorial
4 October 2015, Amsterdam, Netherlands

The Beast in Your Memory: Modern Exploitation Techniques and Defenses

Lucas Davi, Christopher Liebchen, Ahmad-Reza Sadeghi

CASED, Technische Universität Darmstadt
**Intel Collaborative Research Institute for Secure
Computing at TU Darmstadt, Germany**

<http://trust.cased.de/>

Motivation



- Sophisticated, complex
- Various of different developers
- Native Code

Large attack surface for runtime attacks

[Úlfar Erlingsson, Low-level Software Security: Attacks and Defenses, TR 2007]

Introduction

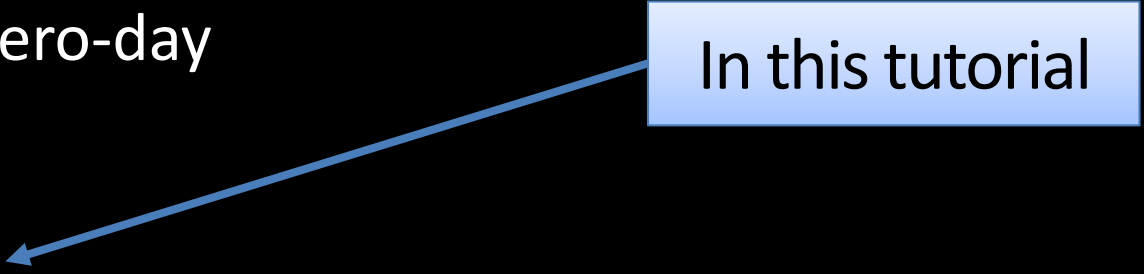
- ◆ Vulnerabilities
 - ◆ Programs continuously suffer from program bugs, e.g., a buffer overflow
 - ◆ Memory errors
 - ◆ CVE statistics; zero-day
- ◆ Runtime Attack 
 - ◆ Exploitation of program vulnerabilities to perform malicious program actions
 - ◆ Control-flow attack; runtime exploit

In this tutorial

Three Decades of Runtime Attacks

Morris Worm
1988

return-into-
libc
Solar Designer
1997

Return-oriented
programming
Shacham
CCS 2007

Continuing Arms
Race

Code
Injection
AlephOne
1996

Borrowed
Code Chunk
Exploitation
Krahmer
2005

...

Are these attacks relevant?



Relevance and Impact

High Impact of Attacks

- Web browsers repeatedly exploited in pwn2own contests
- Zero-day issues exploited in Stuxnet/Duqu [Microsoft, BH 2012]
- iOS jailbreak

Industry Efforts on Defenses

- Microsoft EMET (Enhanced Mitigation Experience Toolkit) includes a ROP detection engine
- Microsoft Control Flow Guard (CFG) in Windows 10
- Google's compiler extension VTV (virtual table verification)

Hot Topic of Research

- A large body of recent literature on attacks and defenses

Stagefright [Drake, BlackHat 2015]

These issues in Stagefright code critically expose 95% of Android devices, an estimated 950 million devices

Zimperium Blog

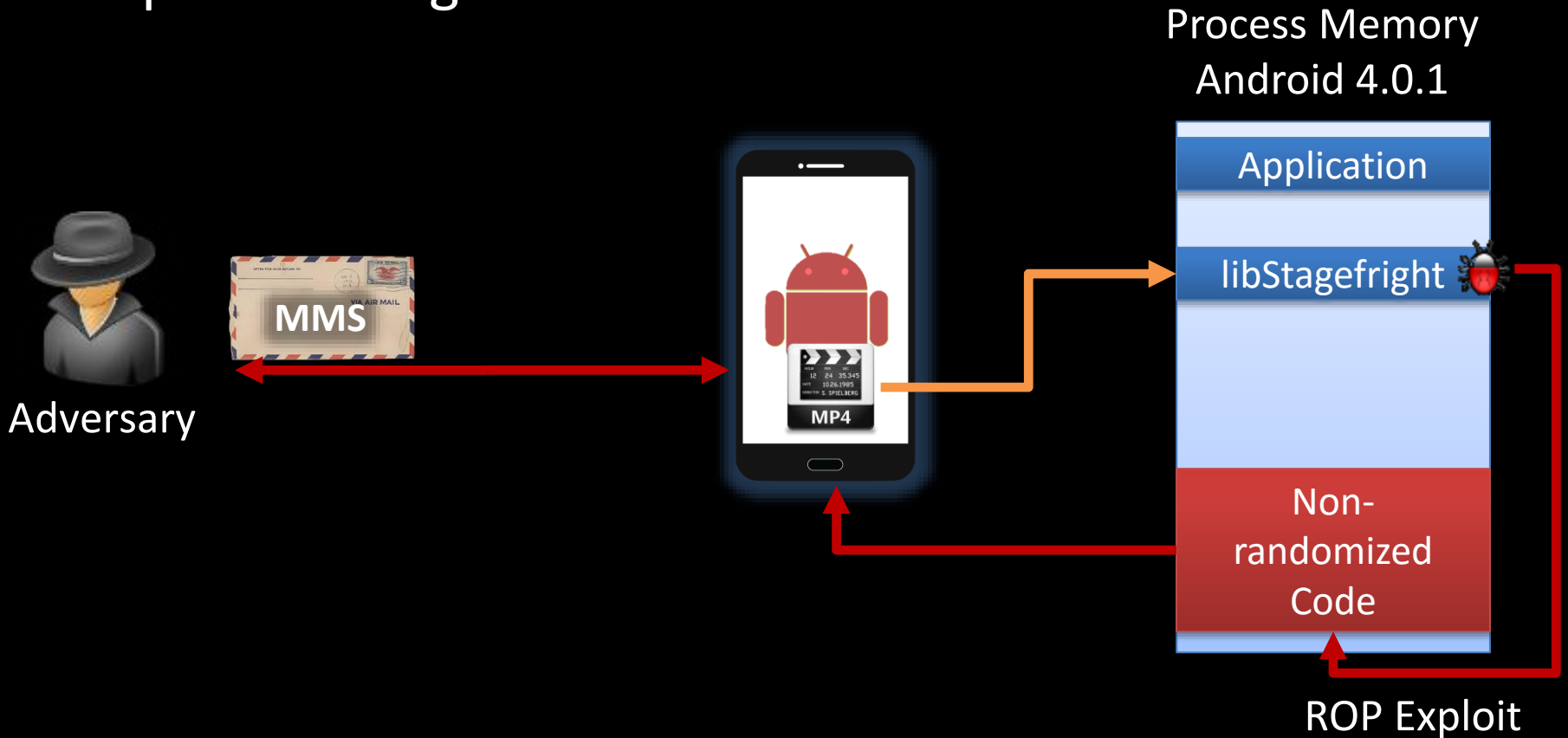

**But runtime exploits have also some
“good” side-effects**



Apple iPhone Jailbreak

Disable signature verification and escalate privileges to root



Request

http://www.jailbreakme.com/_/iPhone3,1_4.0.pdf



- 1) Exploit PDF Viewer Vulnerability by means of **Return-Oriented Programming**
- 2) Start Jailbreak
- 3) Download required system files
- 4) Jailbreak Done

Outline of This Lecture

BASICS

- What is a runtime attack?
- Why today's attacks use code reuse?

CODE-REUSE ATTACKS

- What is return-oriented programming (ROP) and how does it work?

CURRENT SECURITY RESEARCH

- Can code randomization (ASLR) help?
- How do control-flow integrity (CFI) solutions such as Microsoft EMET or kBouncer aim at preventing ROP?
- Can the latest CFI solutions be bypassed? What's next?

BASICS

What is a runtime attack ?



Big Picture: Program Compilation



Source Code
C



```
COPY ( buffer[8], *usr_input )
```

Compile

Executable
binary

```
mov reg0[0-3], reg1[0-3]  
mov reg0[4-n], reg1[4-n]
```

reg0

buffer[8]

reg1

usr_input

Big Picture: Program Execution (1/3)

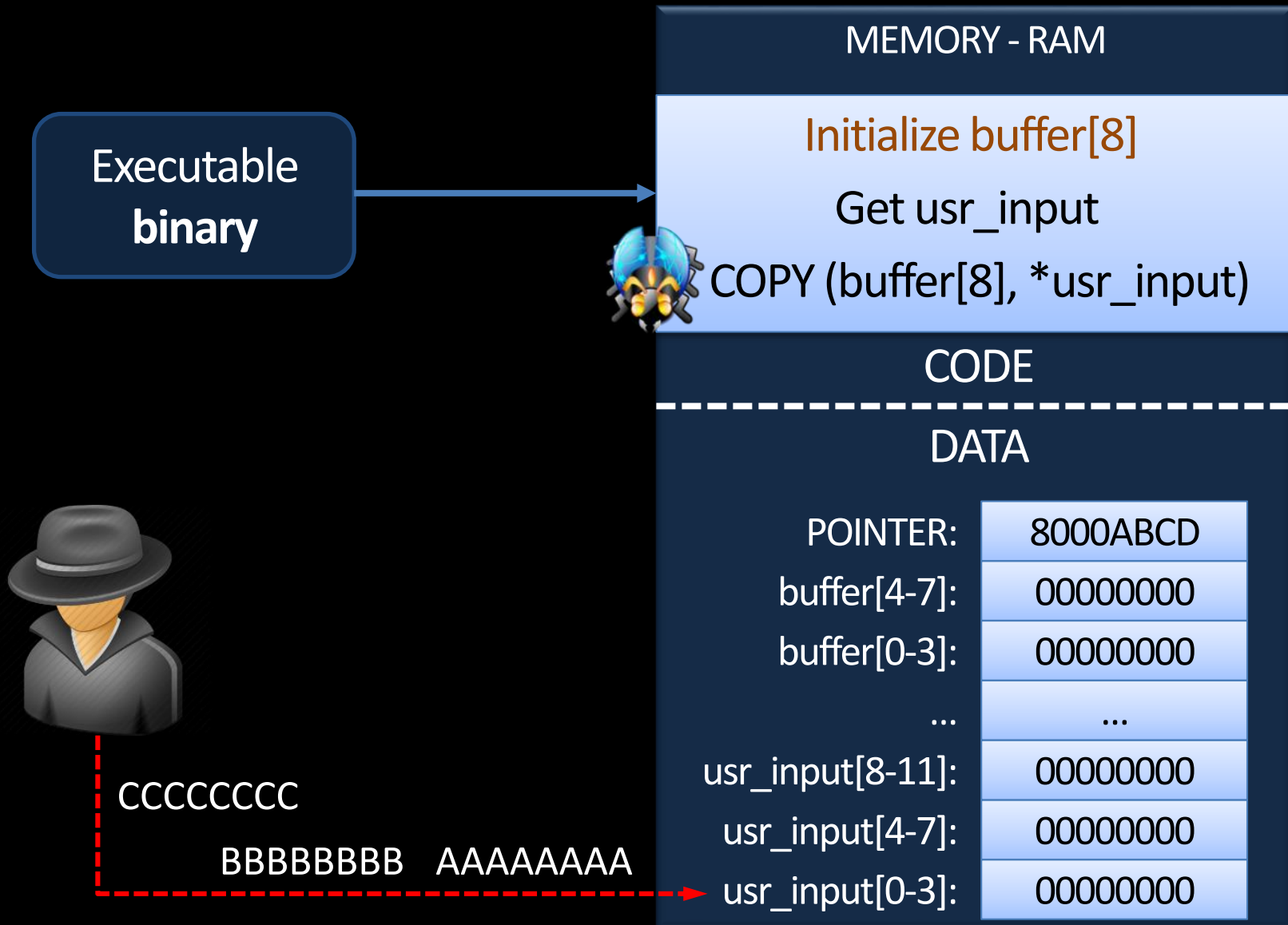

Big Picture: Program Execution (2/3)

Executable
binary



MEMORY - RAM

Initialize buffer[8]

Get usr_input

COPY (buffer[8], *usr_input)

CODE

DATA

POINTER: 8000ABCD

buffer[4-7]: 00000000

buffer[0-3]: 00000000

...

usr_input[8-11]: CCCCCCCC

usr_input[4-7]: BBBBBBBB

usr_input[0-3]: AAAAAAAA



Big Picture: Program Execution (3/3)

Executable
binary



MEMORY - RAM

Initialize buffer[8]

Get usr_input

COPY (buffer[8], *usr_input)

CODE

DATA

POINTER: CCCCCCCC

buffer[4-7]: BBBBBBBB

buffer[0-3]: AAAAAAAA

...

usr_input[8-11]: CCCCCCCC

usr_input[4-7]: BBBBBBBB

usr_input[0-3]: AAAAAAAA



Observations

- ♦ There are several observations
 1. A programming error leads to a program-flow deviation
 2. Missing **bounds checking**
 - ♦ Languages like C, C++, or assembler do not automatically enforce bounds checking on data inputs
 3. An adversary can provide inputs that influence the program flow
- ♦ What are the consequences?

General Principle of Code Injection Attacks

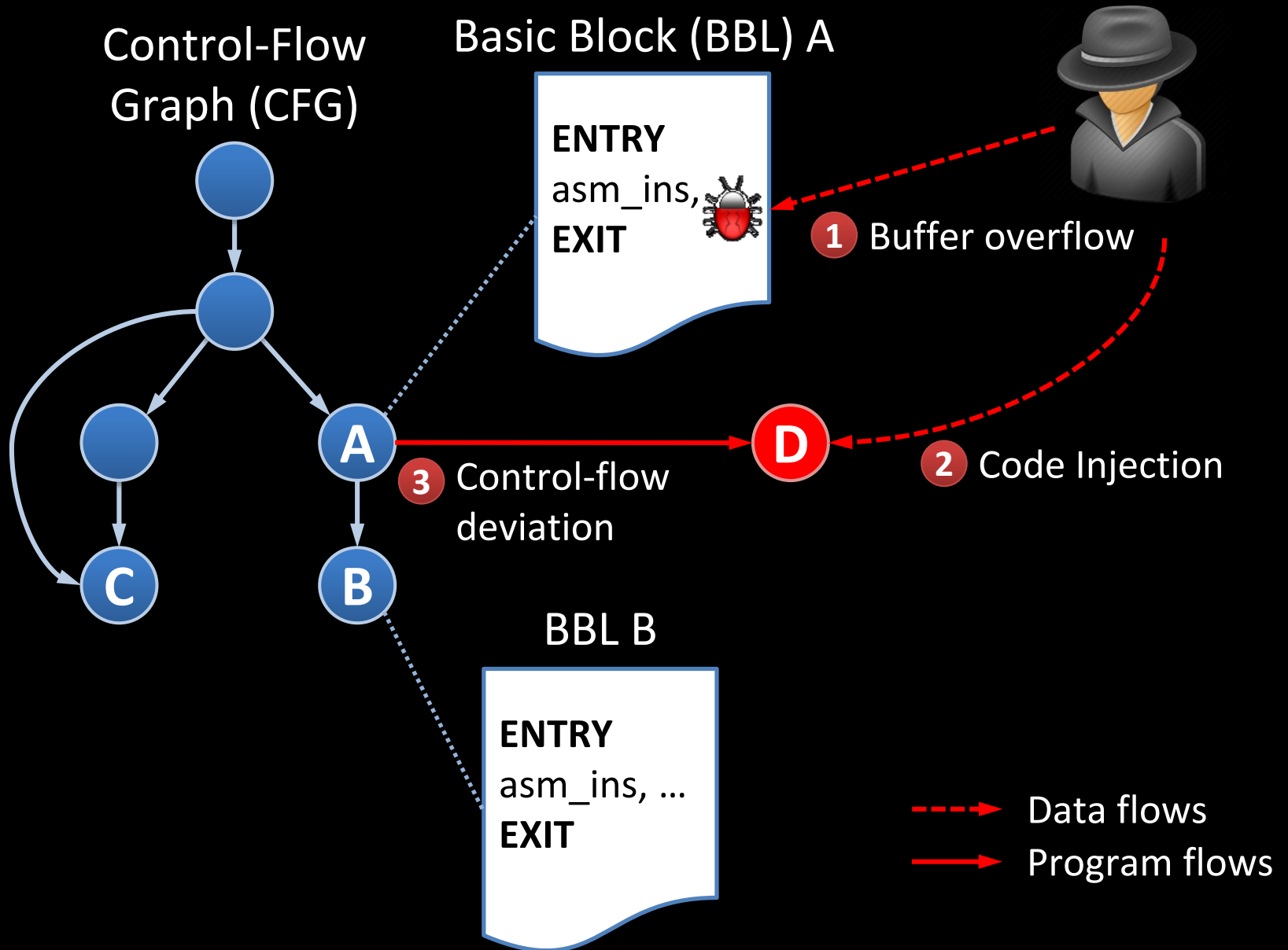

General Principle of Code Reuse Attacks

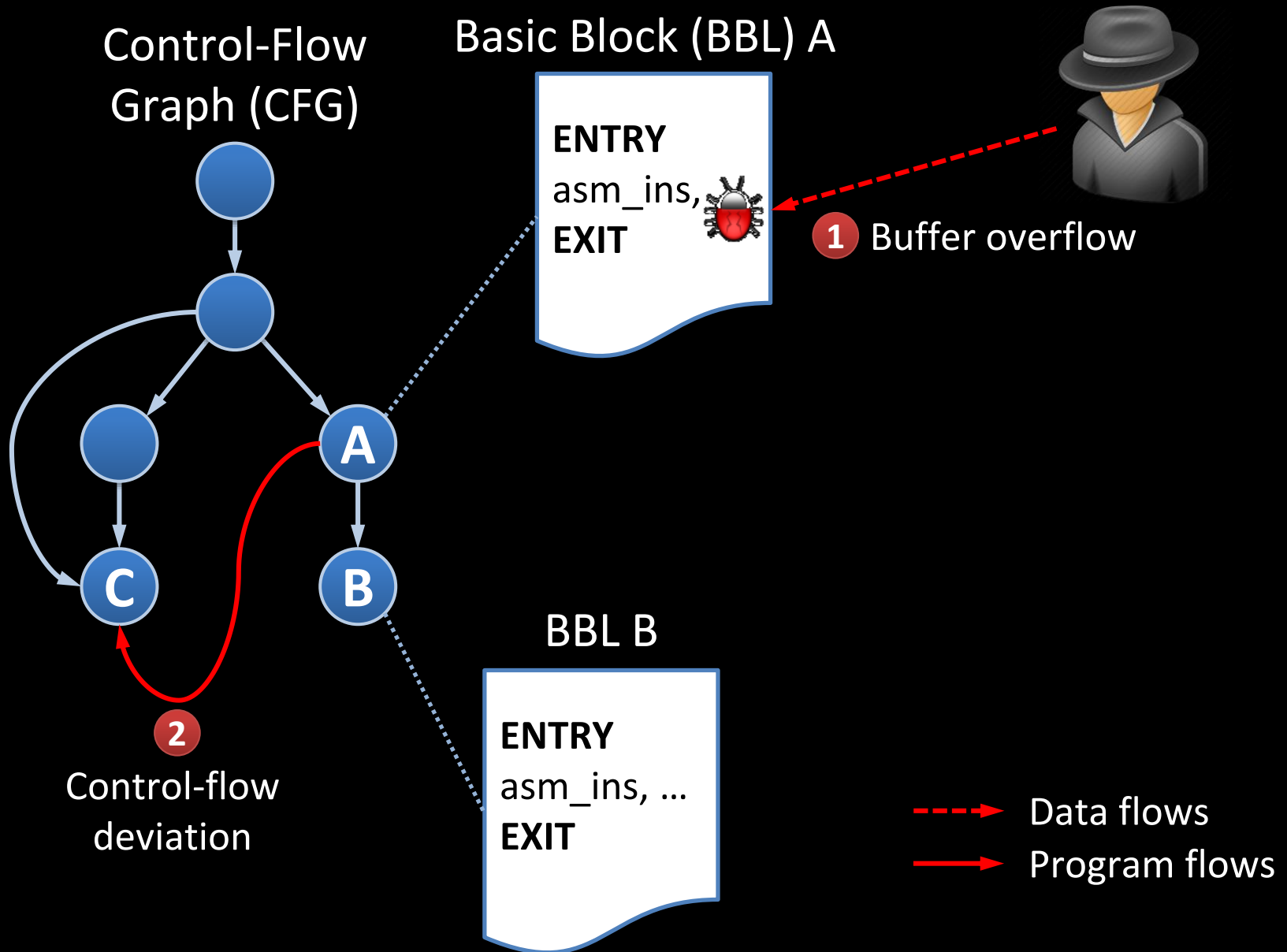

Code Injection vs. Code Reuse

- ◆ Code Injection – *Adding a new **node** to the CFG*
 - ◆ Adversary can execute arbitrary malicious code
 - ◆ open a remote console (classical shellcode)
 - ◆ exploit further vulnerabilities in the OS kernel to install a virus or a backdoor
- ◆ Code Reuse – *Adding a new **path** to the CFG*
 - ◆ Adversary is limited to the code nodes that are available in the CFG
 - ◆ Requires reverse-engineering and static analysis of the code base of a program

BASICS

**Code injection is more powerful;
so why are attacks today
typically using code reuse?**

Data Execution Prevention (DEP)

- ◆ Prevent execution from a writable memory (data) area

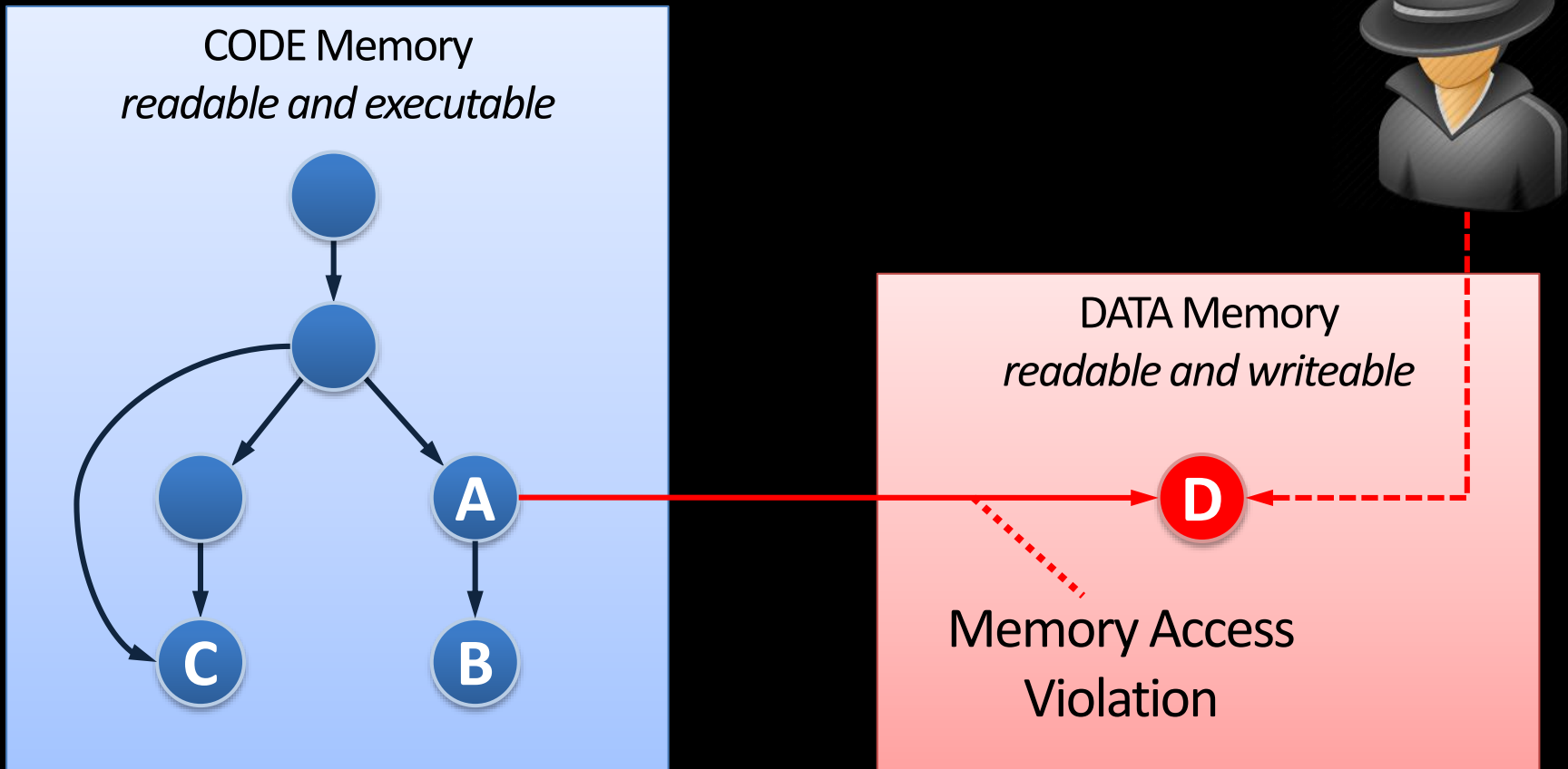

Data Execution Prevention (DEP) cntd.

- ◆ Implementations
 - ◆ Modern OSes enable DEP by default (Windows, Linux, iOS, Android, Mac OSX)
 - ◆ Intel, AMD, and ARM feature a special No-Execute bit to facilitate deployment of DEP
- ◆ Side Note
 - ◆ There are other notions referring to the same principle
 - ◆ $W \oplus X$ – Writeable XOR eXecutable
 - ◆ Non-executable memory

Hybrid Exploits (1/3)

- Today's attacks combine code reuse with code injection

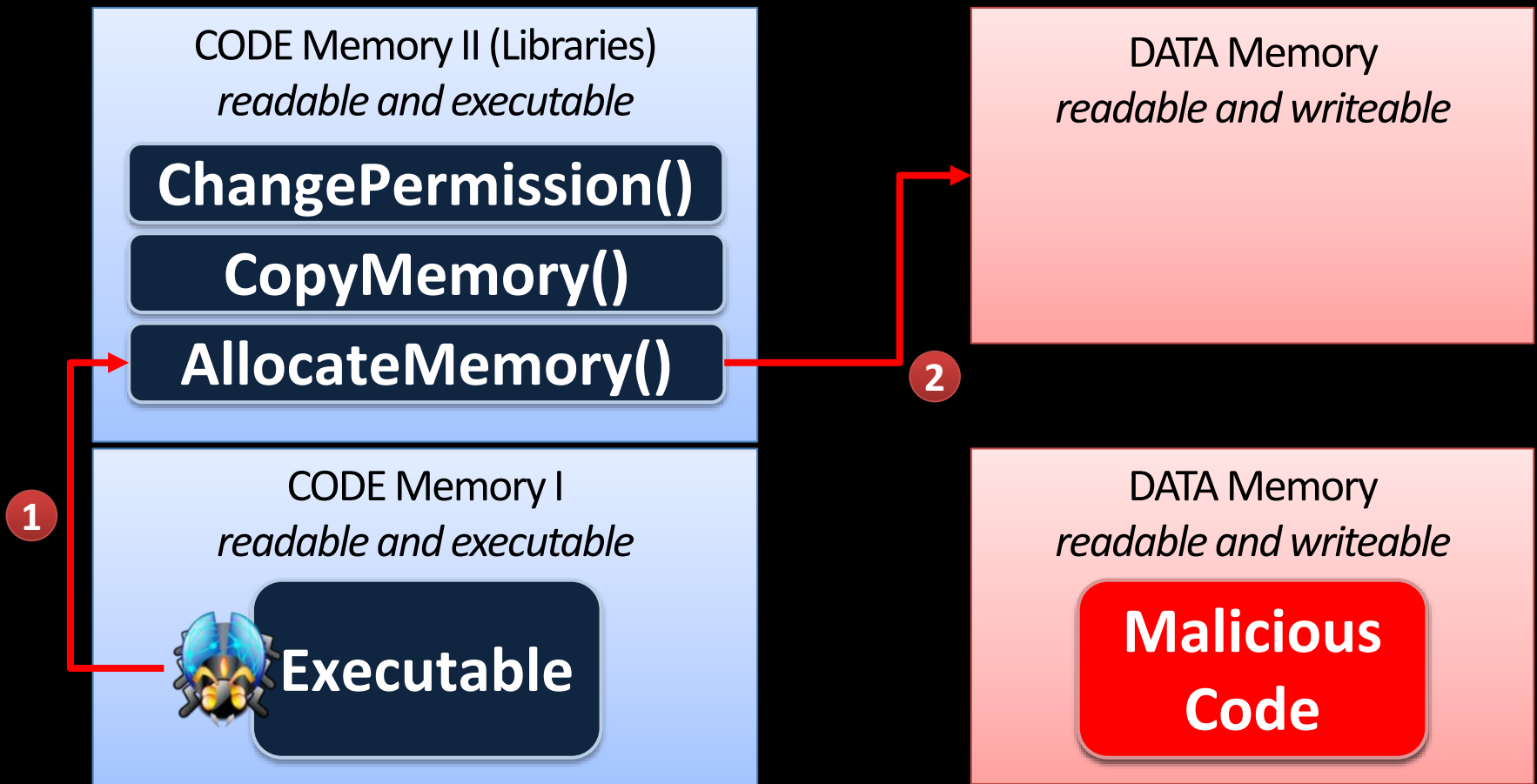

Hybrid Exploits (2/3)

- Today's attacks combine code reuse with code injection

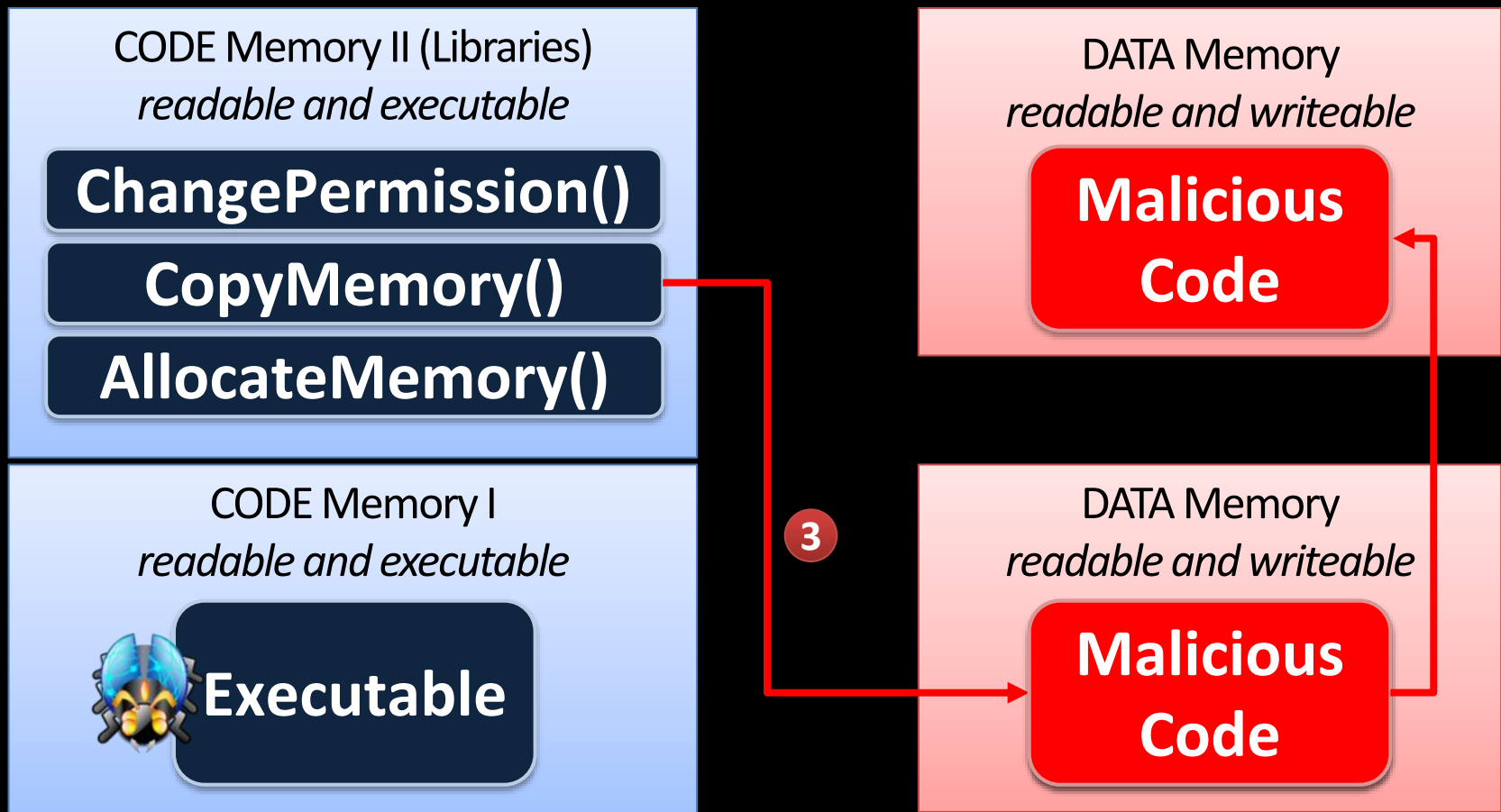

Hybrid Exploits (3/3)

- Today's attacks combine code reuse with code injection

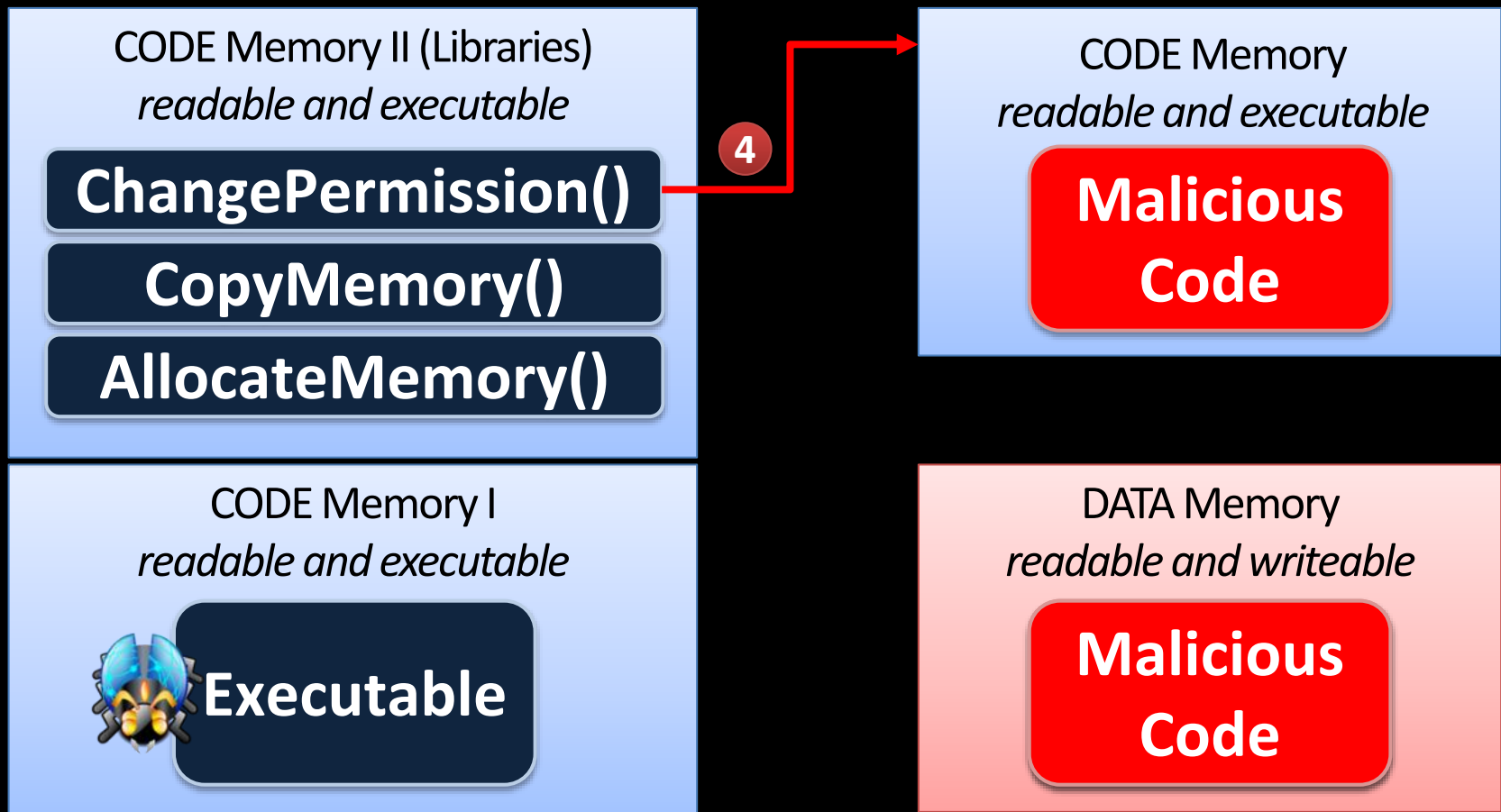

CODE-REUSE ATTACKS

What is ROP and how does it work?

The Big Picture

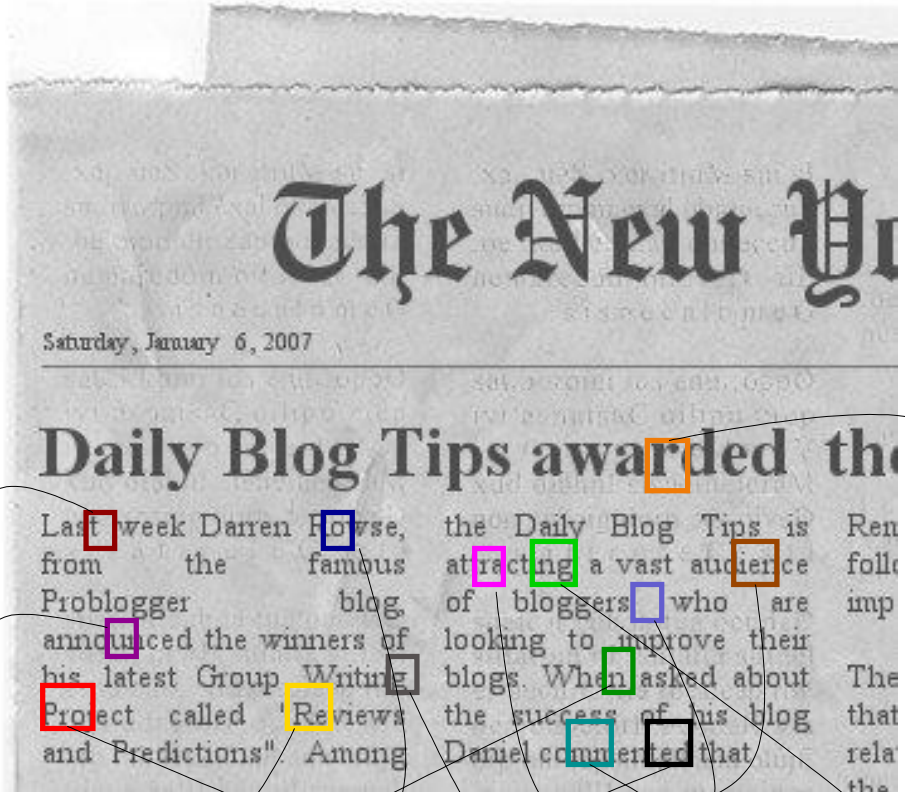

Re t u r n o r i e n t e d P r o g r a m m i n g

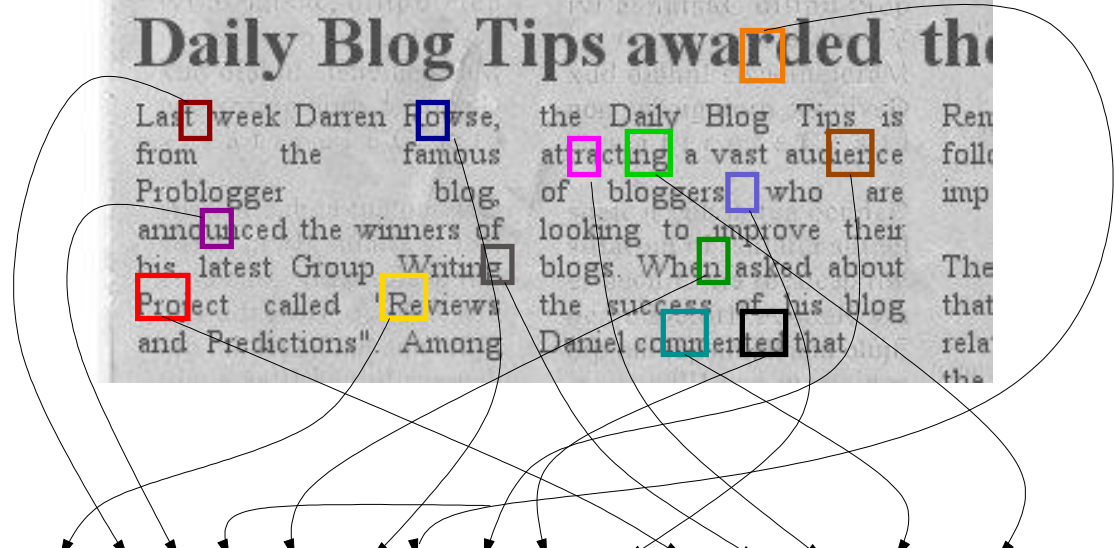

**Selected background on ARM registers,
stack layout, and calling convention**

ARM Overview

- ♦ ARM stands for **Advanced RISC Machine**
- ♦ Main application area: Mobile phones, smartphones (Apple iPhone, Google Android), music players, tablets, and some netbooks
- ♦ Advantage: **Low power consumption**
- ♦ Follows **RISC design**
 - ♦ Mostly single-cycle execution
 - ♦ Fixed instruction length
 - ♦ Dedicated load and store instructions
- ♦ ARM features XN (e**X**ecute **N**ever) Bit

ARM Overview

- ◆ Some features of ARM
 - ◆ Conditional Execution
 - ◆ Two Instruction Sets
 - ◆ **ARM (32-Bit)**
 - ◆ The traditional instruction set
 - ◆ **THUMB (16-Bit)**
 - ◆ Suitable for devices that provide limited memory space
 - ◆ The processor can **exchange** the instruction set on-the-fly
 - ◆ Both instruction sets may occur in a **single** program
 - ◆ 3-Register-Instruction Set
 - ◆ **instruction** *destination, source, source*



ARM Registers

- ♦ ARM's 32 Bit processor features 16 registers
- ♦ All registers r0 to r15 are directly accessible

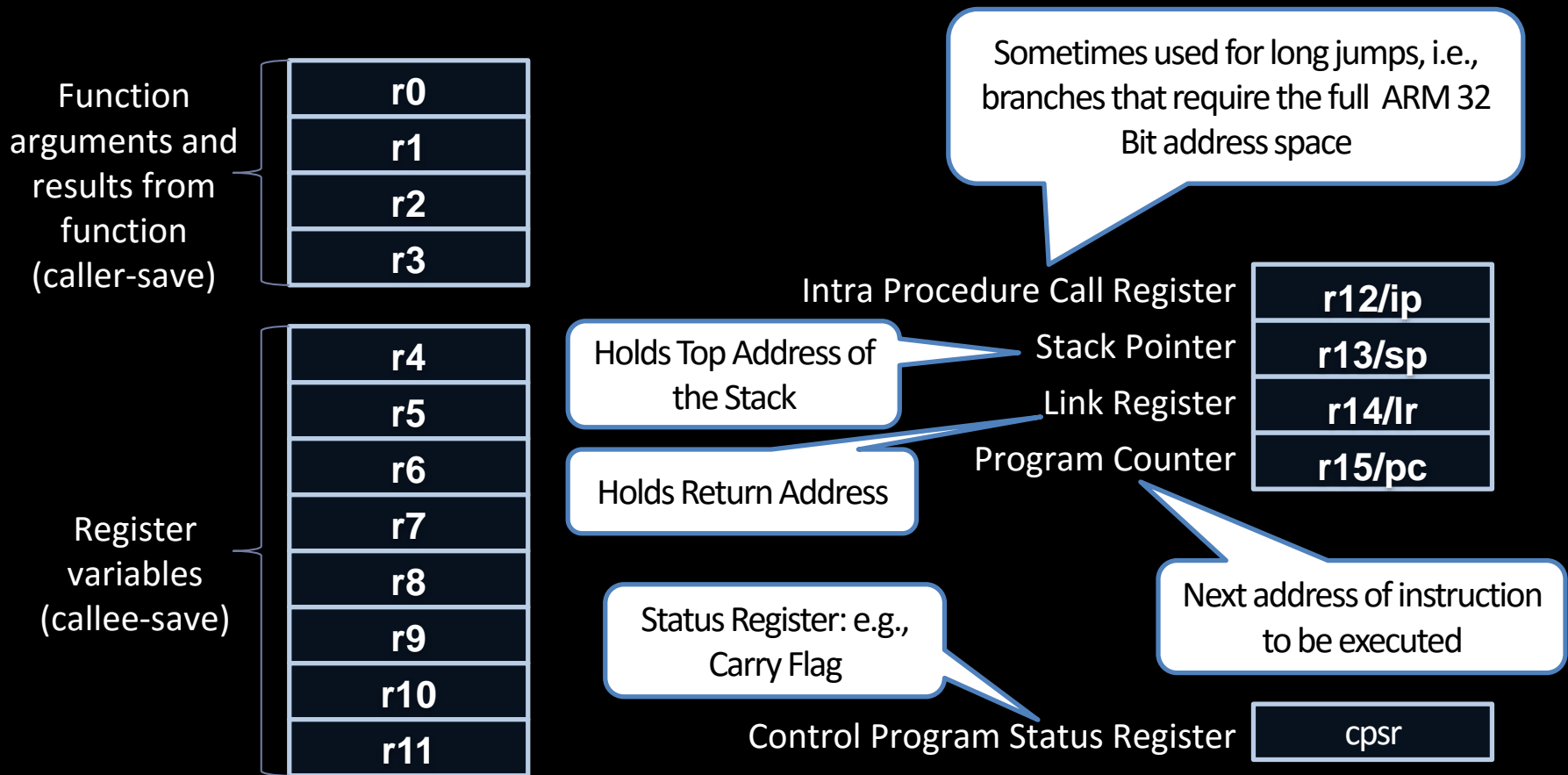

ARM Stack Layout

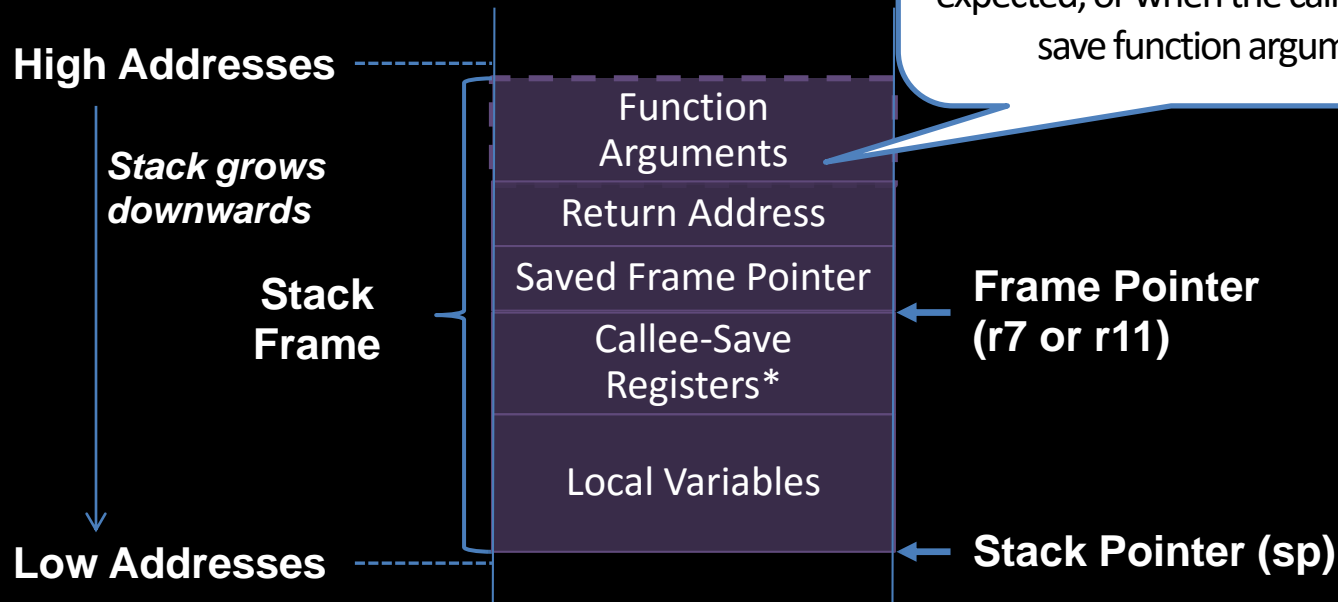

* Note that a subroutine does not always store all callee-save registers (r4 to r11); instead it stores those registers that it really uses/changes

Function Calls on ARM

Branch with Link

BL addr

- ◆ Branches to **addr**, and stores the return address in link register **lr/r14**
- ◆ The return address is simply the address that follows the **BL** instruction

Branch with Link and eXchange instruction set

BLX addr|reg

- ◆ Branches to **addr|reg**, and stores the return address in **lr/r14**
- ◆ This instruction allows the **exchange** between ARM and THUMB
 - ◆ ARM->THUMB: LSB=1
 - ◆ THUMB->ARM: LSB=0

Function Returns on ARM

*Branch with eXchange
instruction set*

BX lr

- ◆ Branches to the return address stored in the link register **lr**
- ◆ Register-based return for leaf functions

POP {pc}

- ◆ Pops top of the stack into the program counter **pc/r15**
- ◆ Stack-based return for non-leaf functions

THUMB Example for Calling Convention

- ◆ Function Call: **BL Function_A**
 - ◆ The **BL** instruction automatically loads the return address into the link register **lr**
- ◆ Function Prologue 1: **PUSH {r4,r7,lr}**
 - ◆ Stores callee-save register **r4**, the frame pointer **r7**, and the return address **lr** on the stack
- ◆ Function Prologue 2: **SUB sp,sp,#16**
 - ◆ Allocates **16 Bytes** for local variables on the stack
- ◆ Function Body: **Instructions, ...**
- ◆ Function Epilogue 2: **ADD sp,sp,#16**
 - ◆ Reallocates the space for local variables
- ◆ Function Epilogue 2: **POP {r4,r7,pc}**
 - ◆ The **POP** instruction pops the callee-save register **r4**, the saved frame pointer **r7**, and the return address off the stack which is loaded into the program counter **pc**
 - ◆ Hence, the execution will continue in the main function

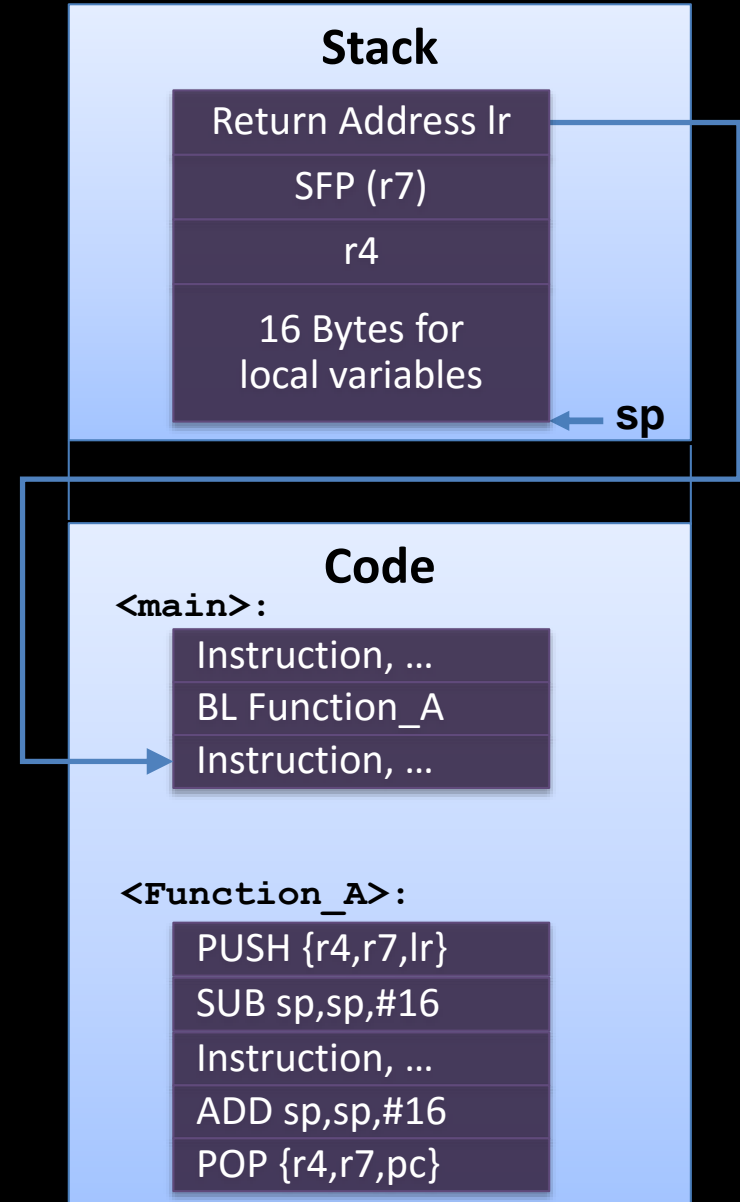

General System and Application Programming Registers

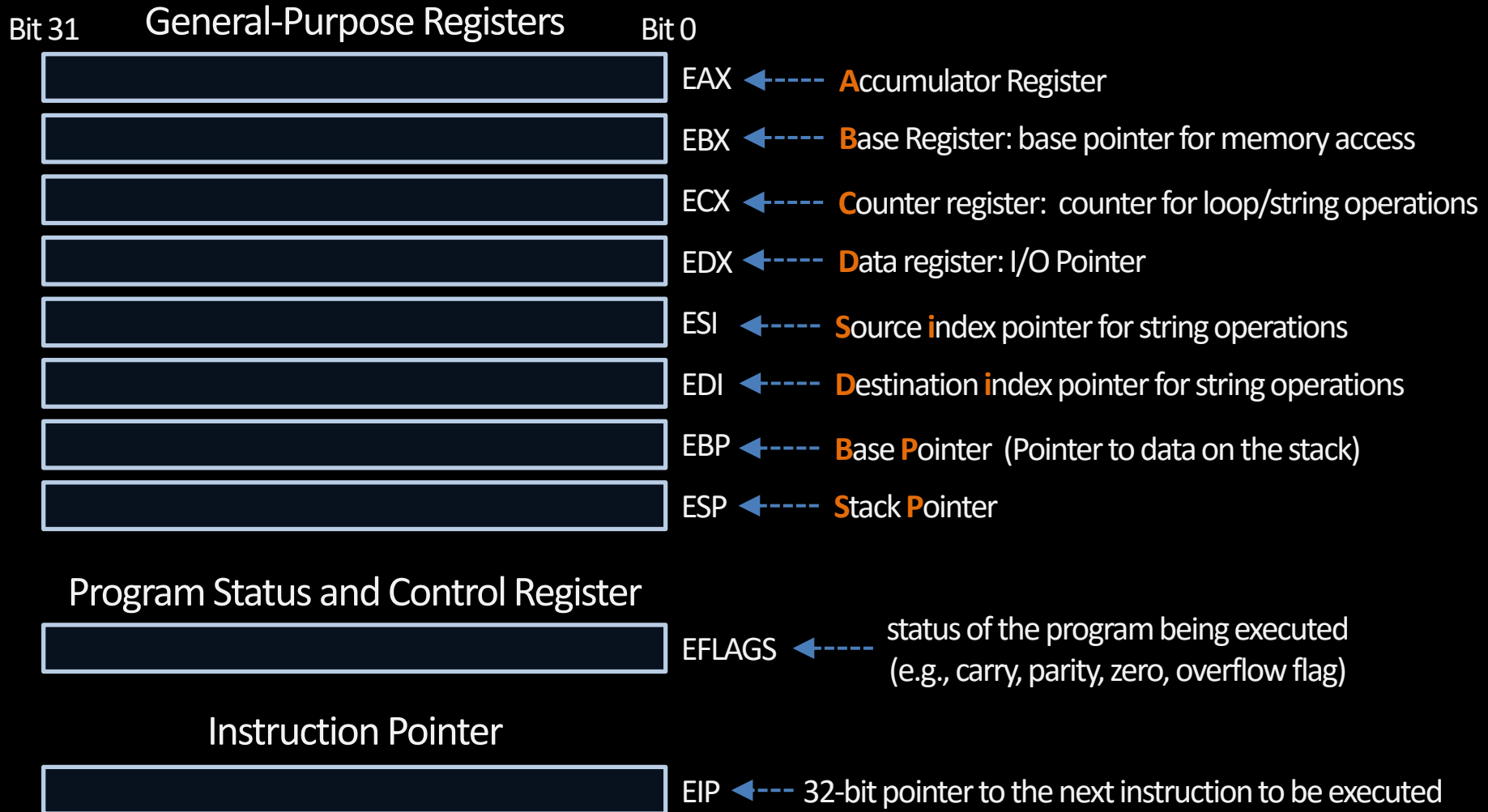

Source: Intel® 64 and IA-32 Architectures Software Developer's Manual Volume 1: Basic Architecture

<http://download.intel.com/products/processor/manual/253665.pdf>

Stack Frame

Each function is associated with one stack frame on the stack

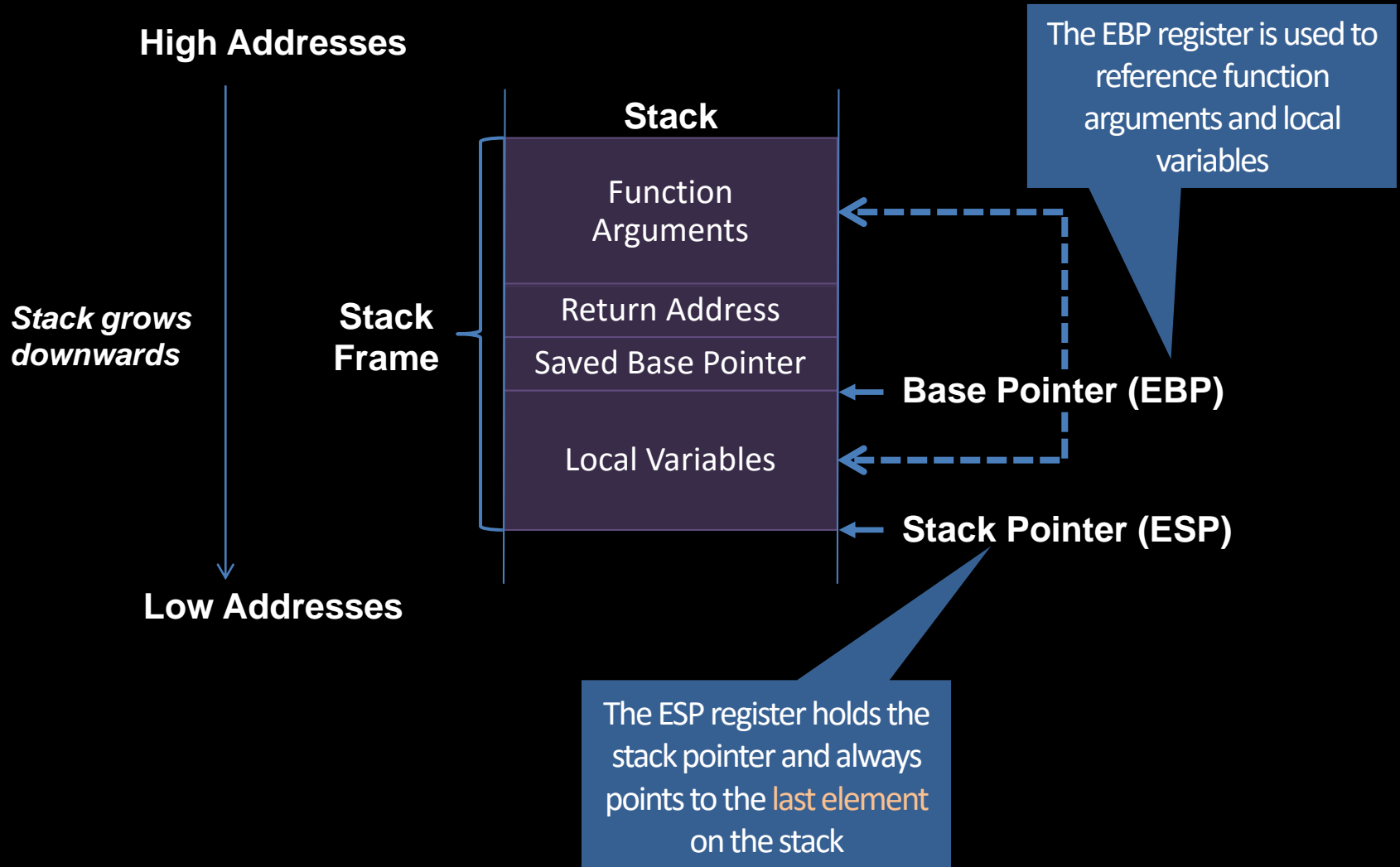

Calling Convention (on Intel x86)

- ◆ Function call performed via the x86 **CALL** instruction
 - ◆ E.g., **CALL Function_A**
 - ◆ The **CALL** instruction automatically pushes the return address on the stack, while the return address simply points to the instruction preceding the call

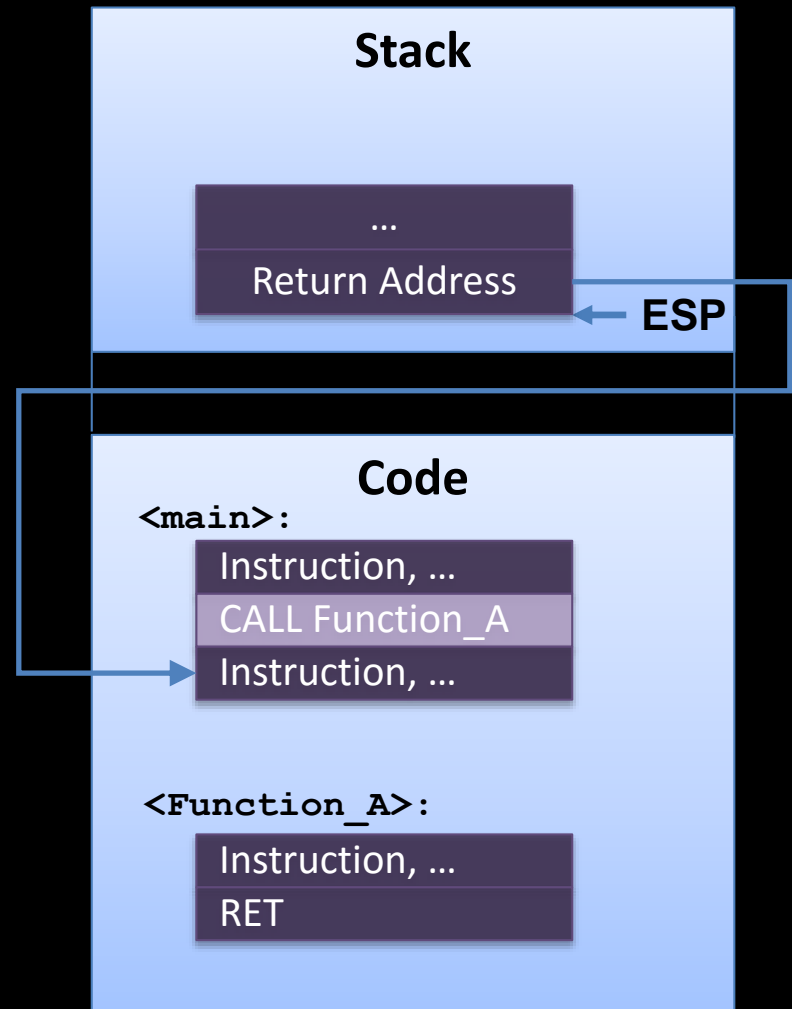

Calling Convention (on Intel x86)

- ◆ Function return is performed via the x86 **RET** instruction
 - ◆ The **RET** instruction pops the return address off the stack and loads it into the instruction pointer (EIP)
 - ◆ Hence, the execution will continue in the main function

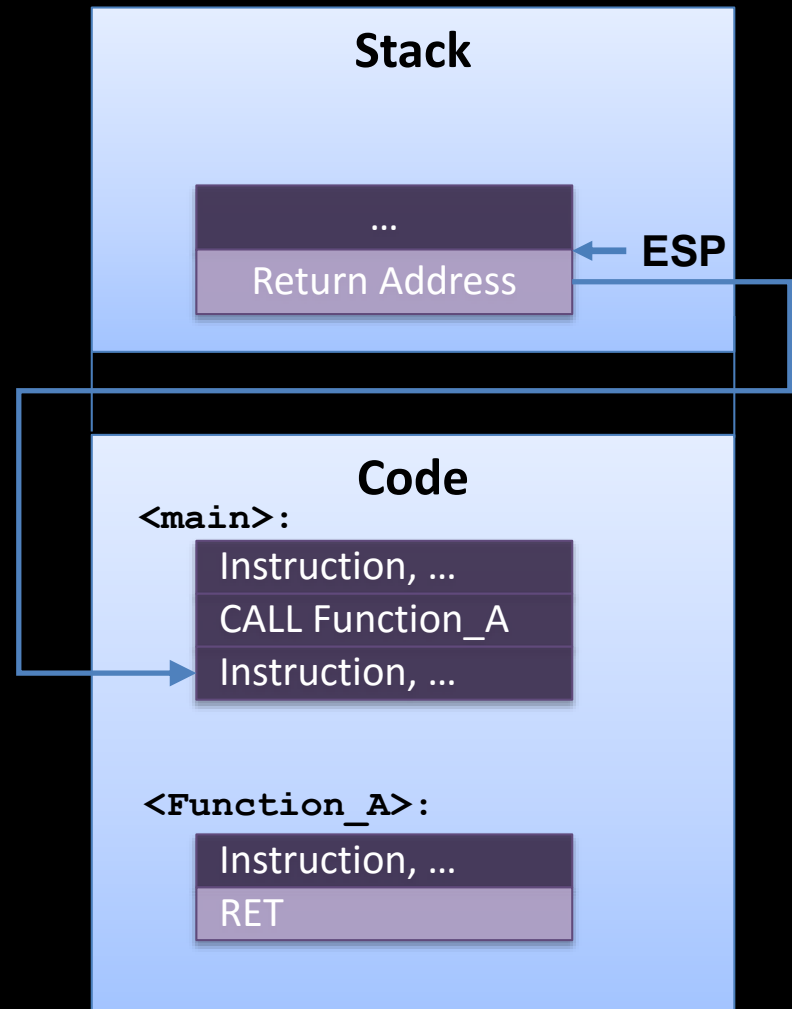

Function Prologue and Epilogue by Example

Assembler Notation: Destination Register is the first operand
- e.g., `MOV %ebp,%esp` moves the value of ESP to register EBP

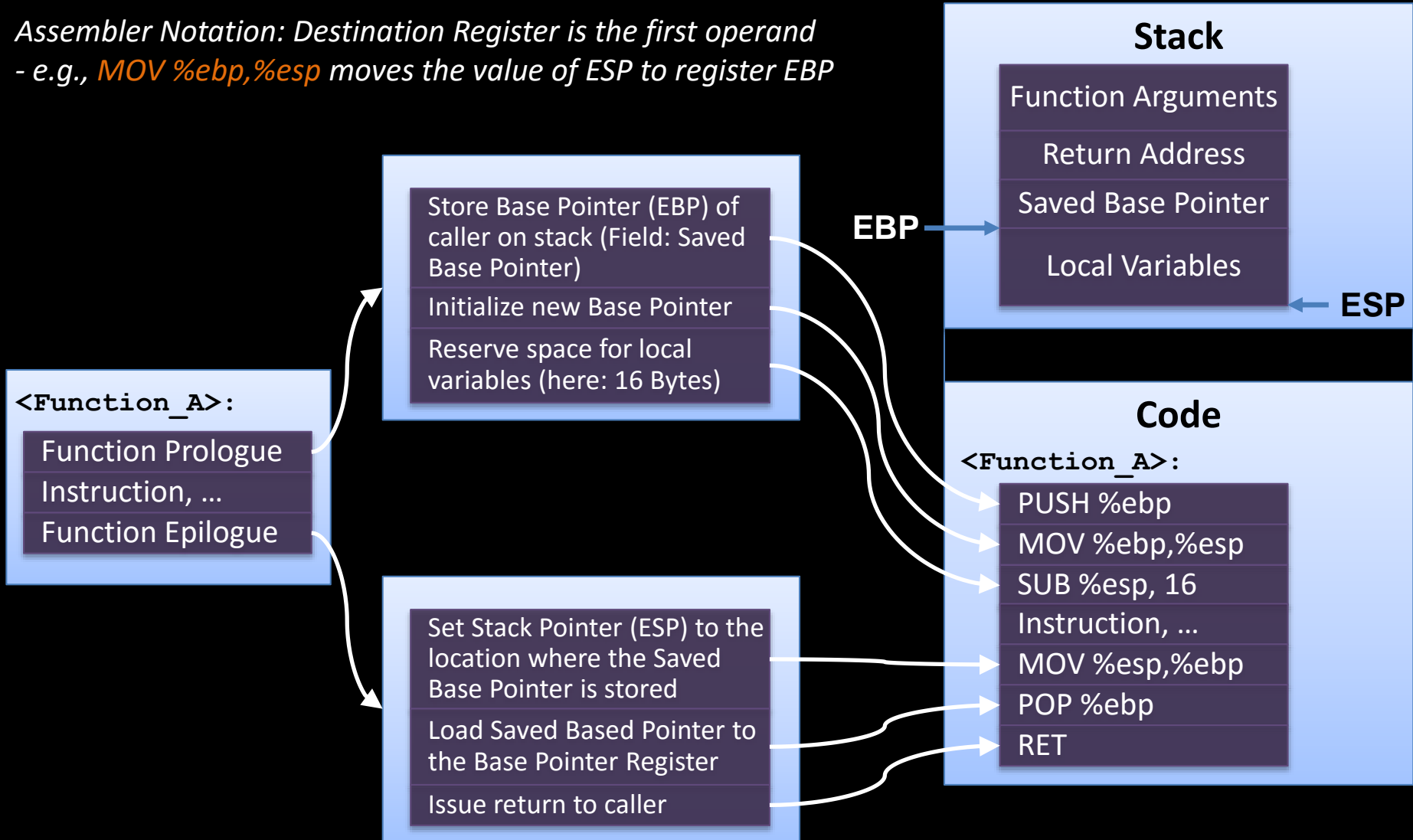

Let's go back to runtime attacks

Running Example

```
#include <stdio.h>
void echo ()
{
    char buffer [80];
    gets (buffer);
    puts (buffer);
}
int main ()
{
    echo ();
    printf (" Done" );
    return 0;
}
```

**Launching a code injection attack
against the vulnerable program**

Call to subroutine echo()

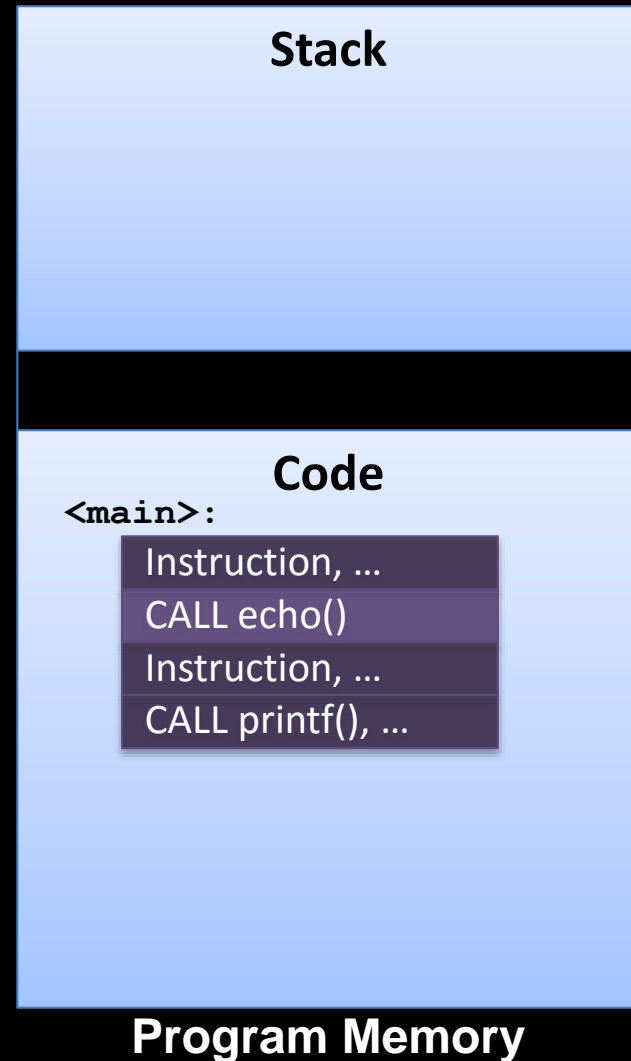

CALL instruction pushes return address onto the Stack

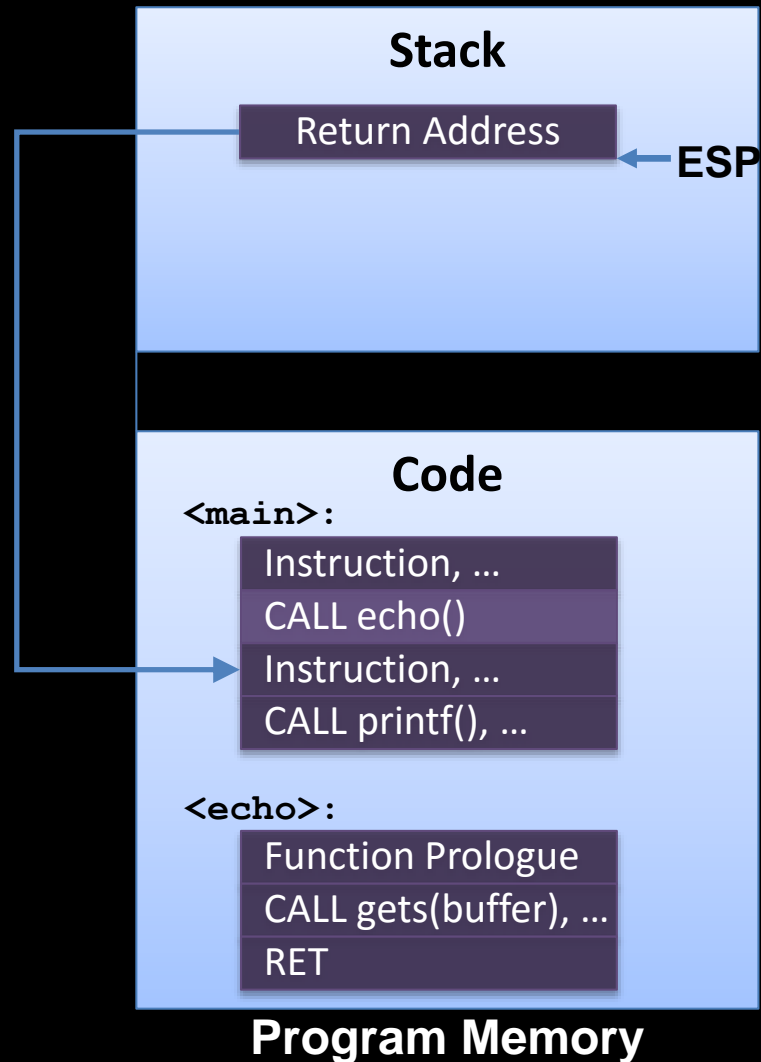

Function prologue of echo() gets executed

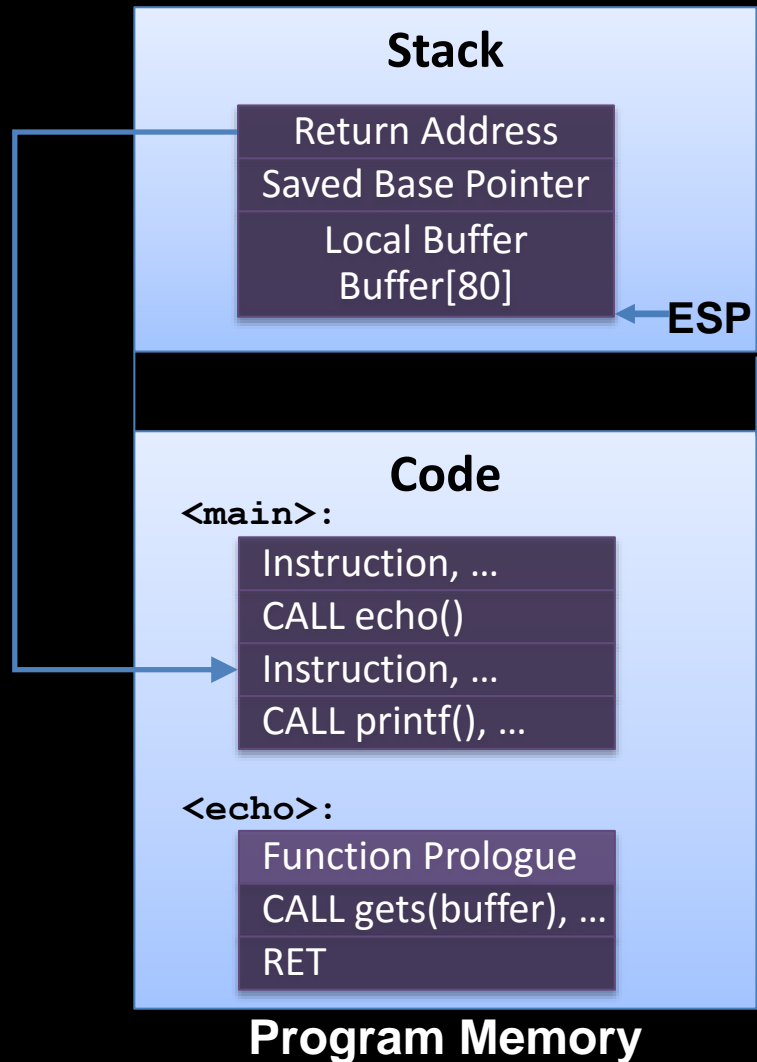

Subroutine call to gets()

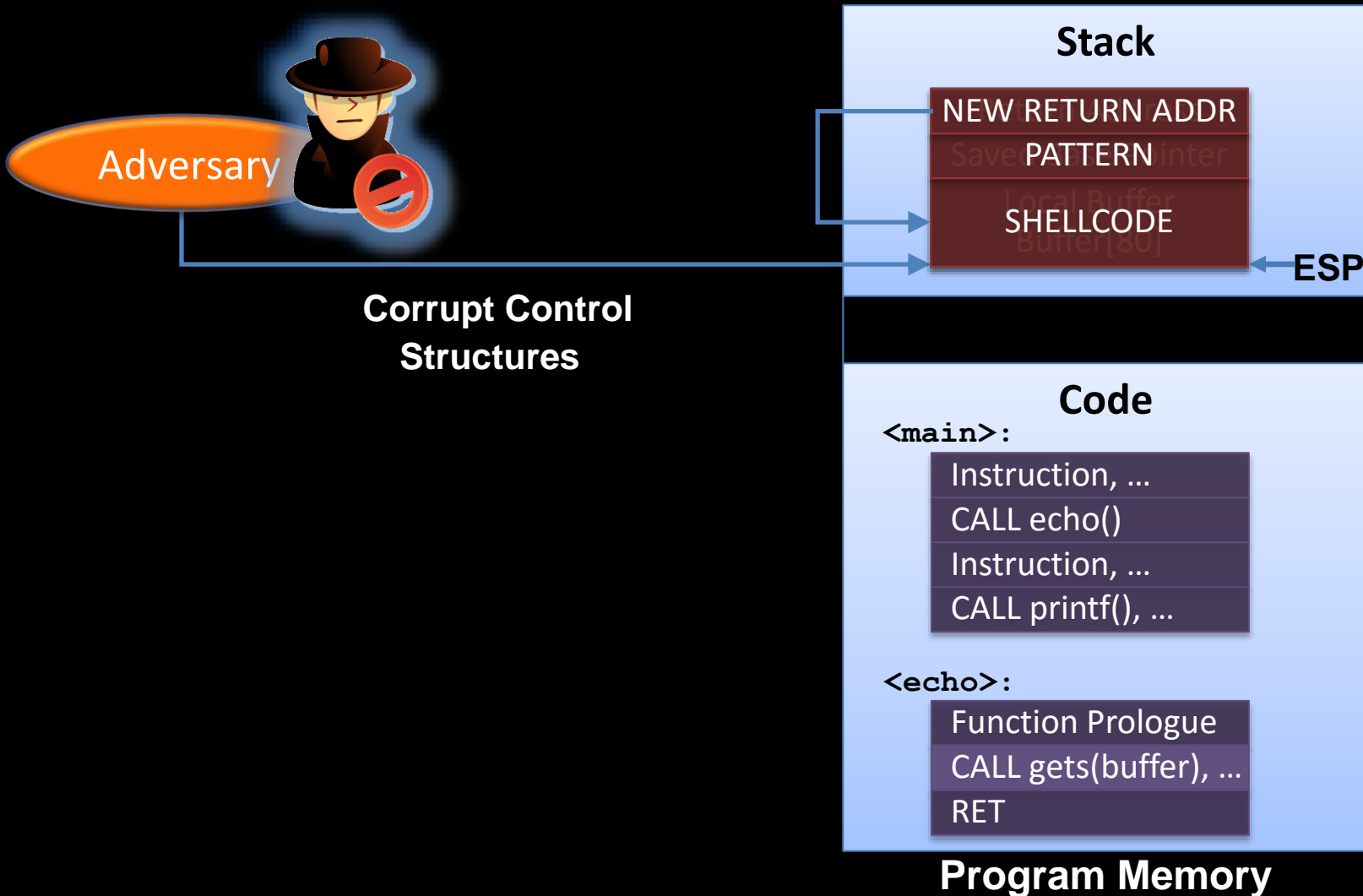



echo() now returns!

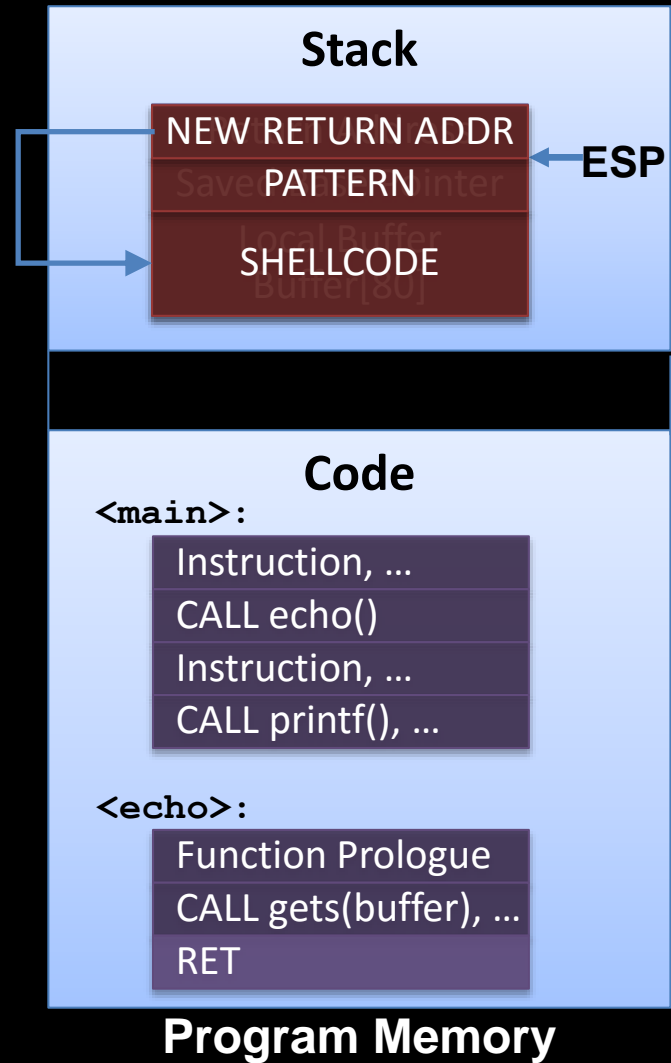

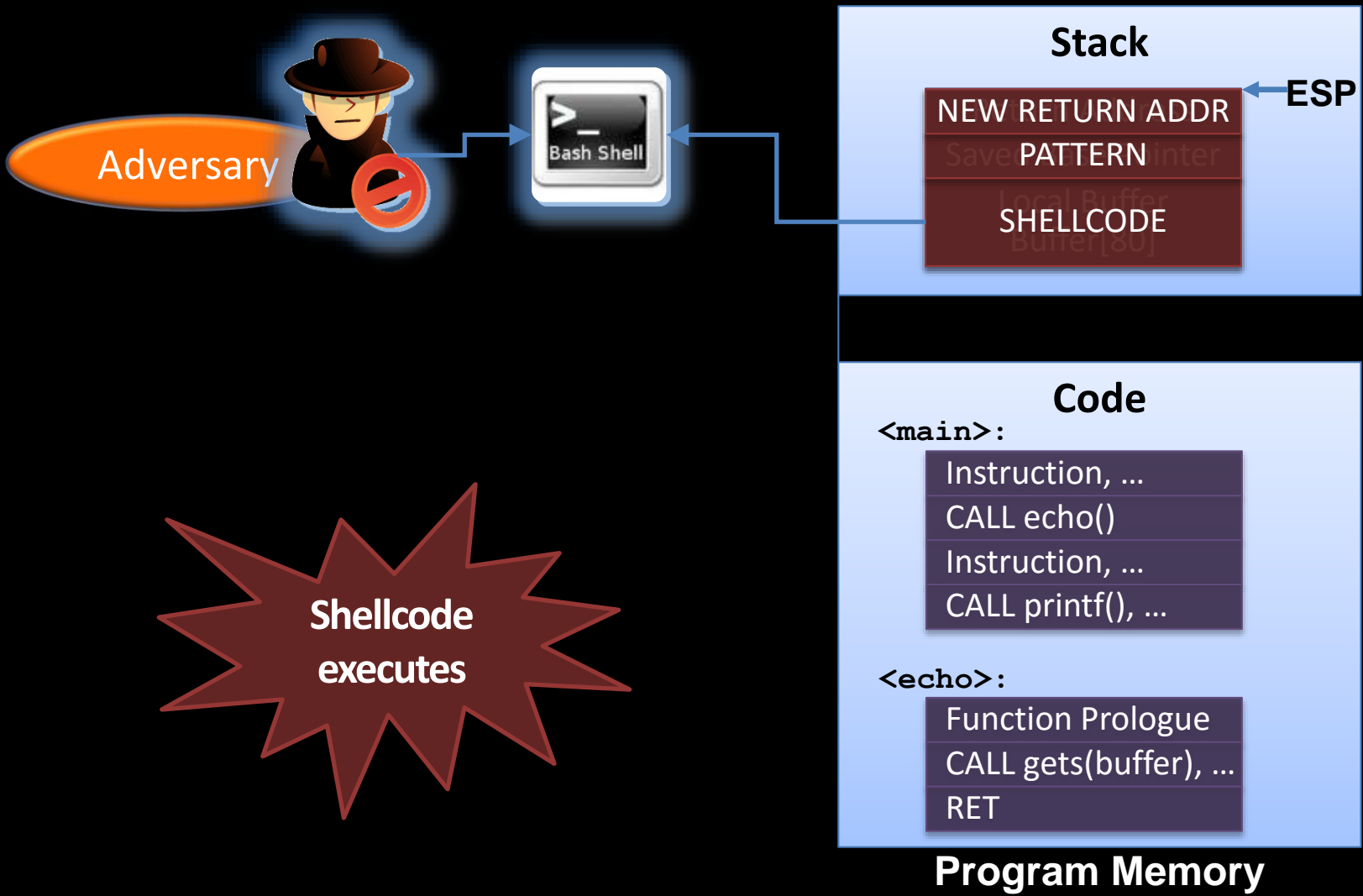

Code Injection on ARM

- ◆ Same attack strategy
- ◆ Implementation differences
 - ◆ BLX/BL instruction used for function call
 - ◆ Function prologue pushes the return address and the callee-save registers on the stack

Code-Reuse Attacks

It started with return-into-libc

[Solar Designer, <http://insecure.org/sploits/linux.libc.return.lpr.sploit.html> 1997]

- ◆ Basic idea of return-into-libc
 - ◆ Redirect execution to functions in shared libraries
 - ◆ Main target is UNIX C library libc
 - ◆ Libc is linked to nearly every Unix program
 - ◆ Defines system calls and other basic facilities such as `open()`, `malloc()`, `printf()`, `system()`, `execve()`, etc.
 - ◆ Attack example: `system (“/bin/sh”), exit()`

Adversary



Inject environment variable

Stack

Program Code

<main>:

Instruction, ...

CALL echo()

Instruction, ...

<echo>:

Function Prologue

CALL gets(buffer), ...

RET

Library Code

<system>:

Function Prologue

Instruction, ...

RET

<exit>:

HALT Program

Environment Variables

\$SHELL = "/bin/sh"

Program Memory

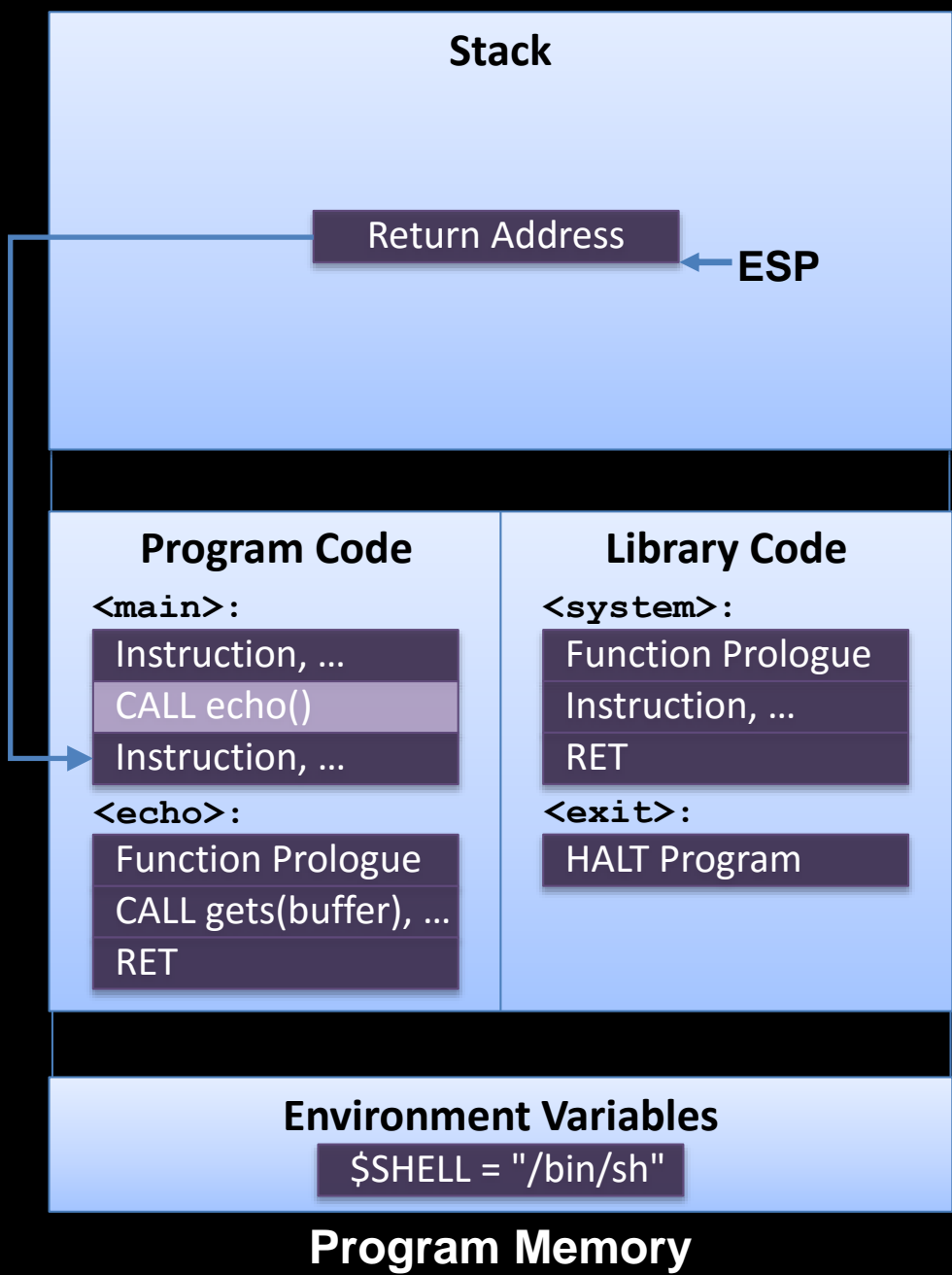

Adversary

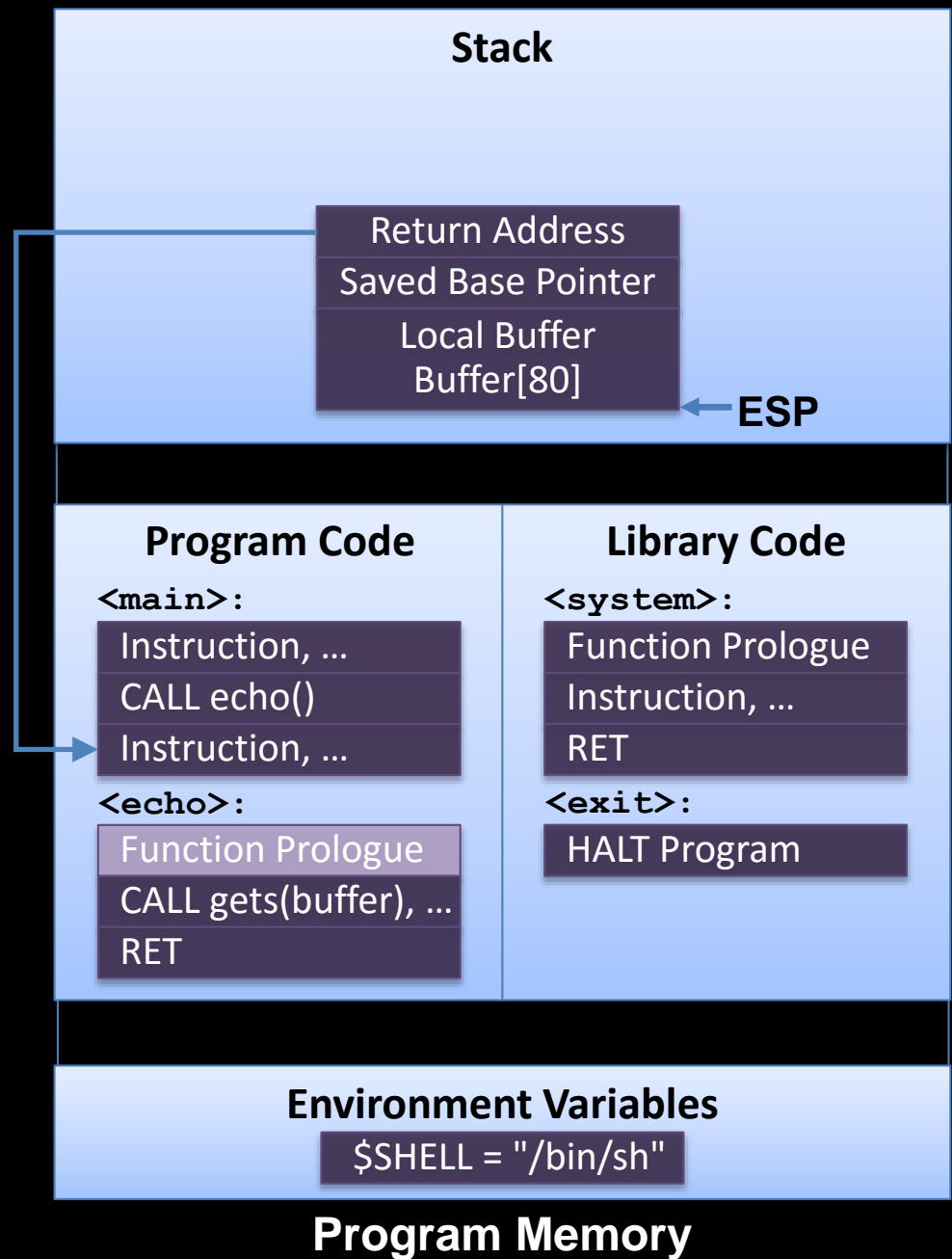



Corrupt Control Structures

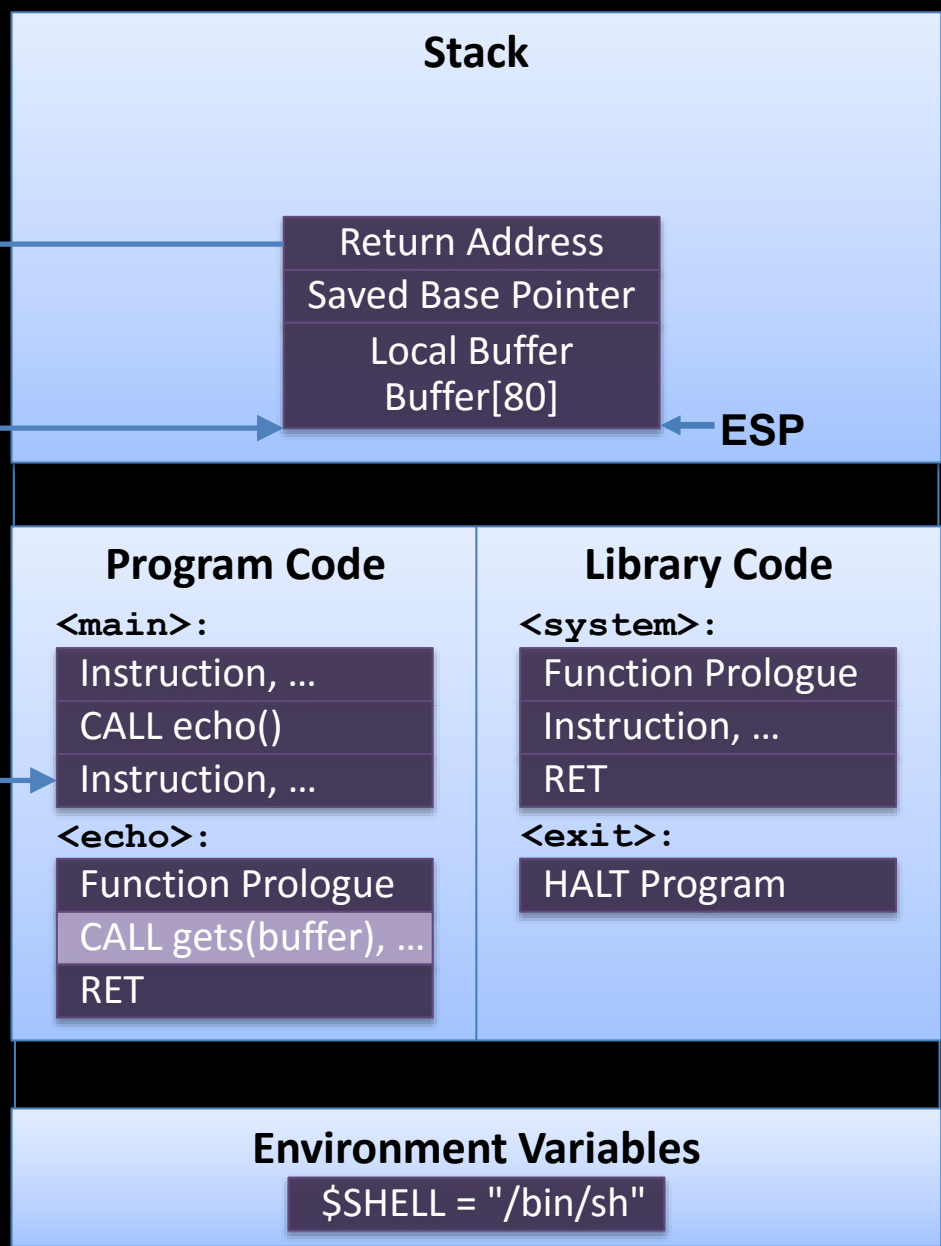

Stack

Return Address
Saved Base Pointer
Local Buffer
Buffer[80]

← ESP

Program Code

<main>:
Instruction, ...
CALL echo()
Instruction, ...

<echo>:
Function Prologue
CALL gets(buffer), ...
RET

Library Code

<system>:
Function Prologue
Instruction, ...
RET

<exit>:
HALT Program

Environment Variables

\$SHELL = "/bin/sh"

Program Memory



Corrupt Control Structures

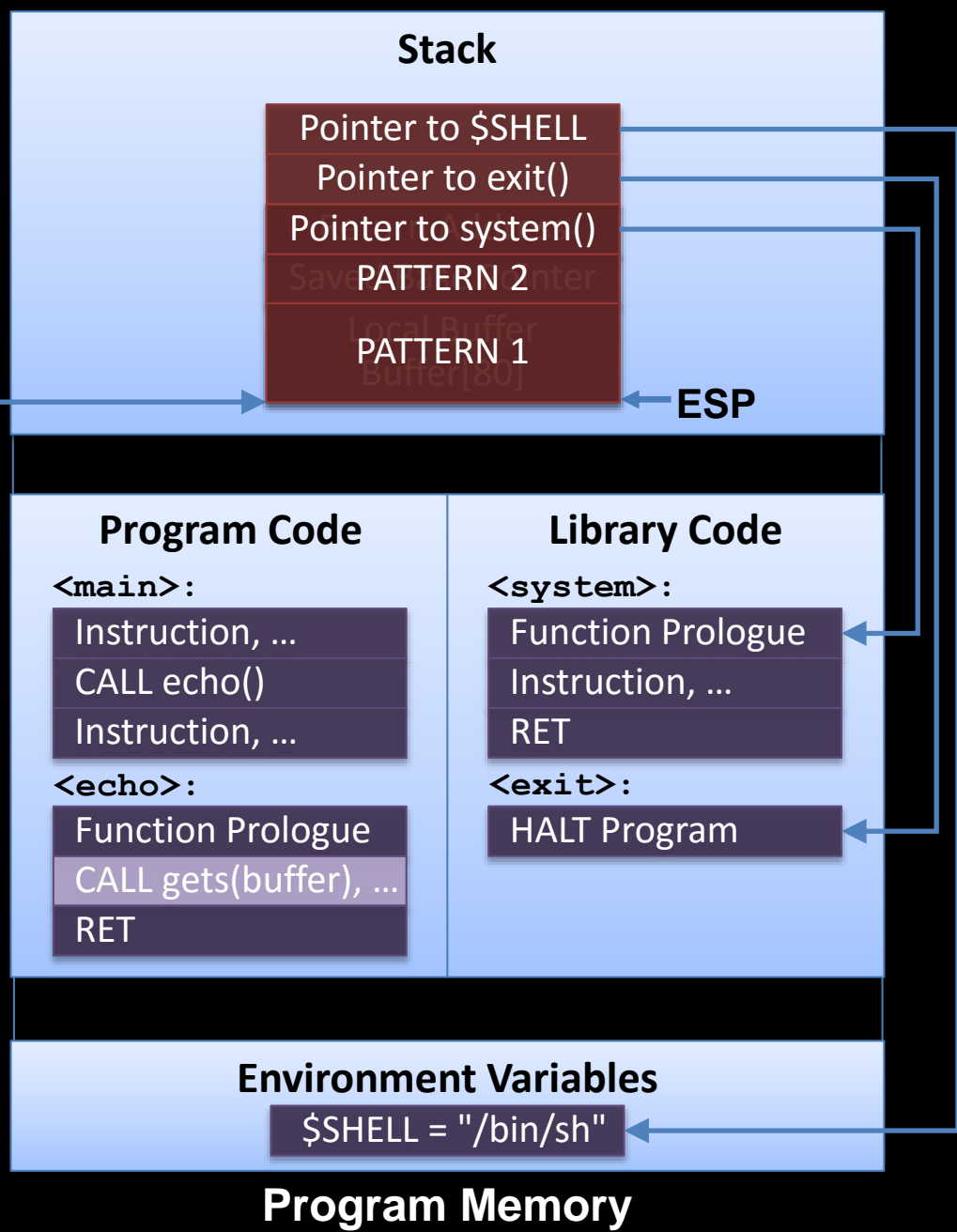

Adversary



echo() now returns!

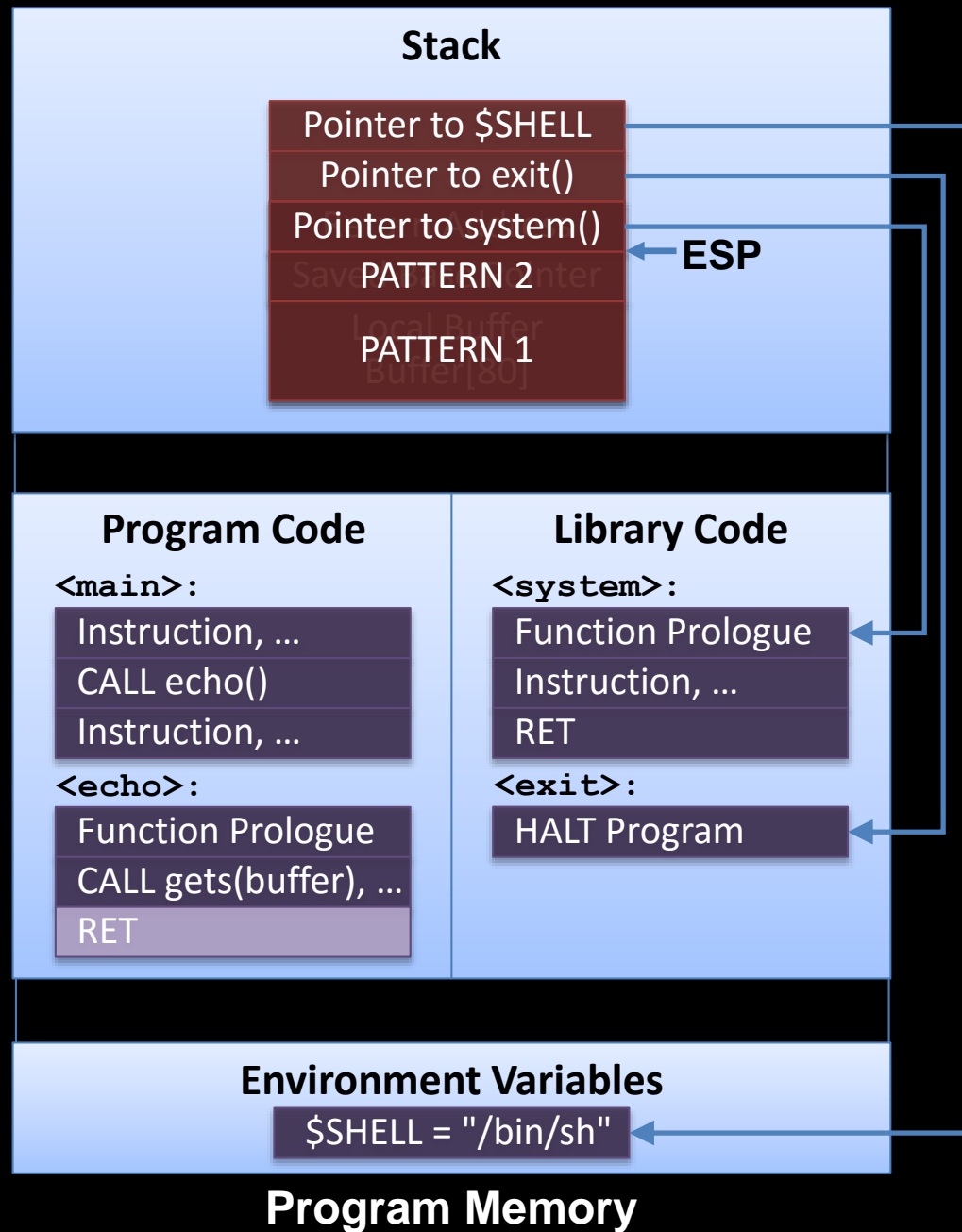

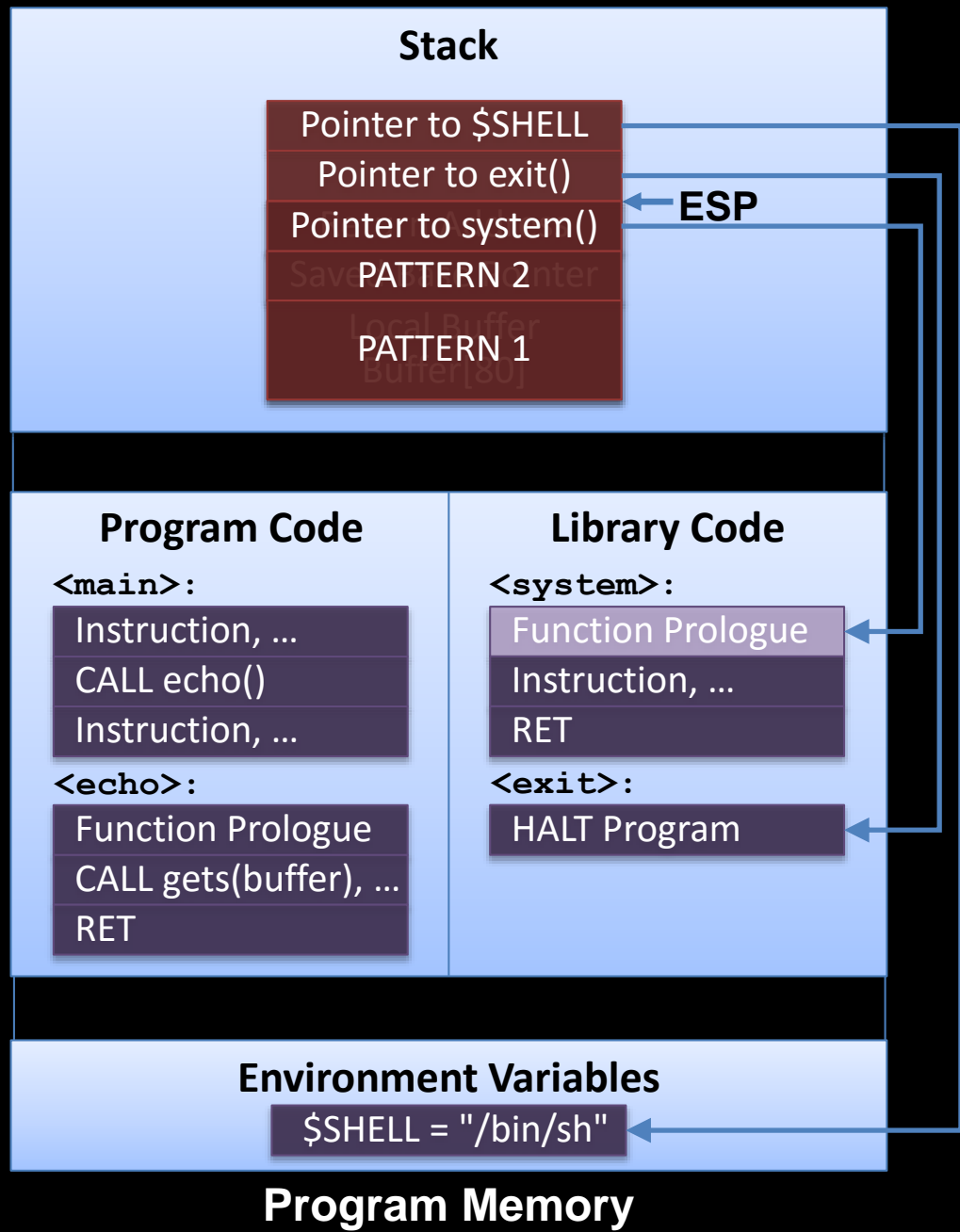

Adversary

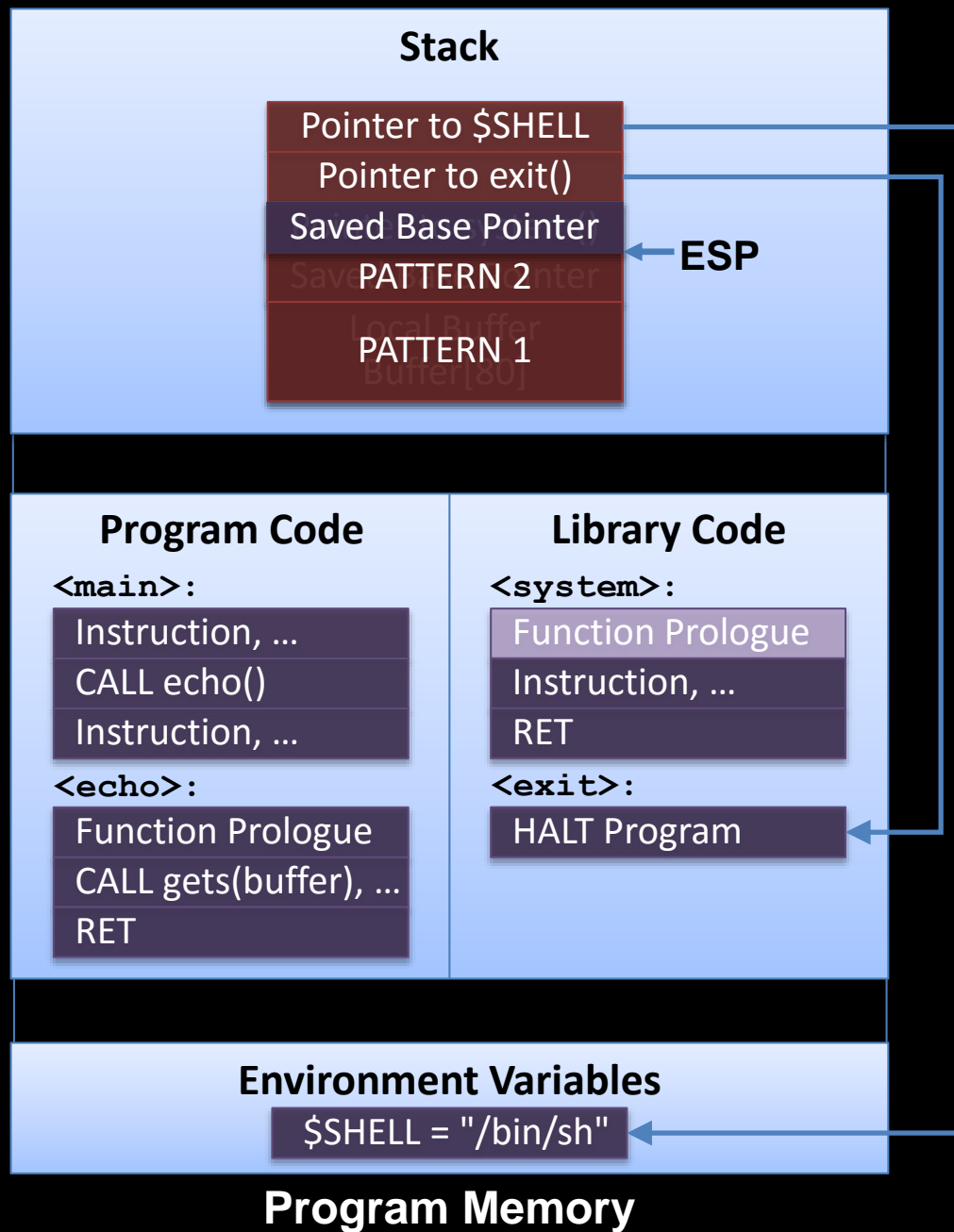



system ("/bin/sh")

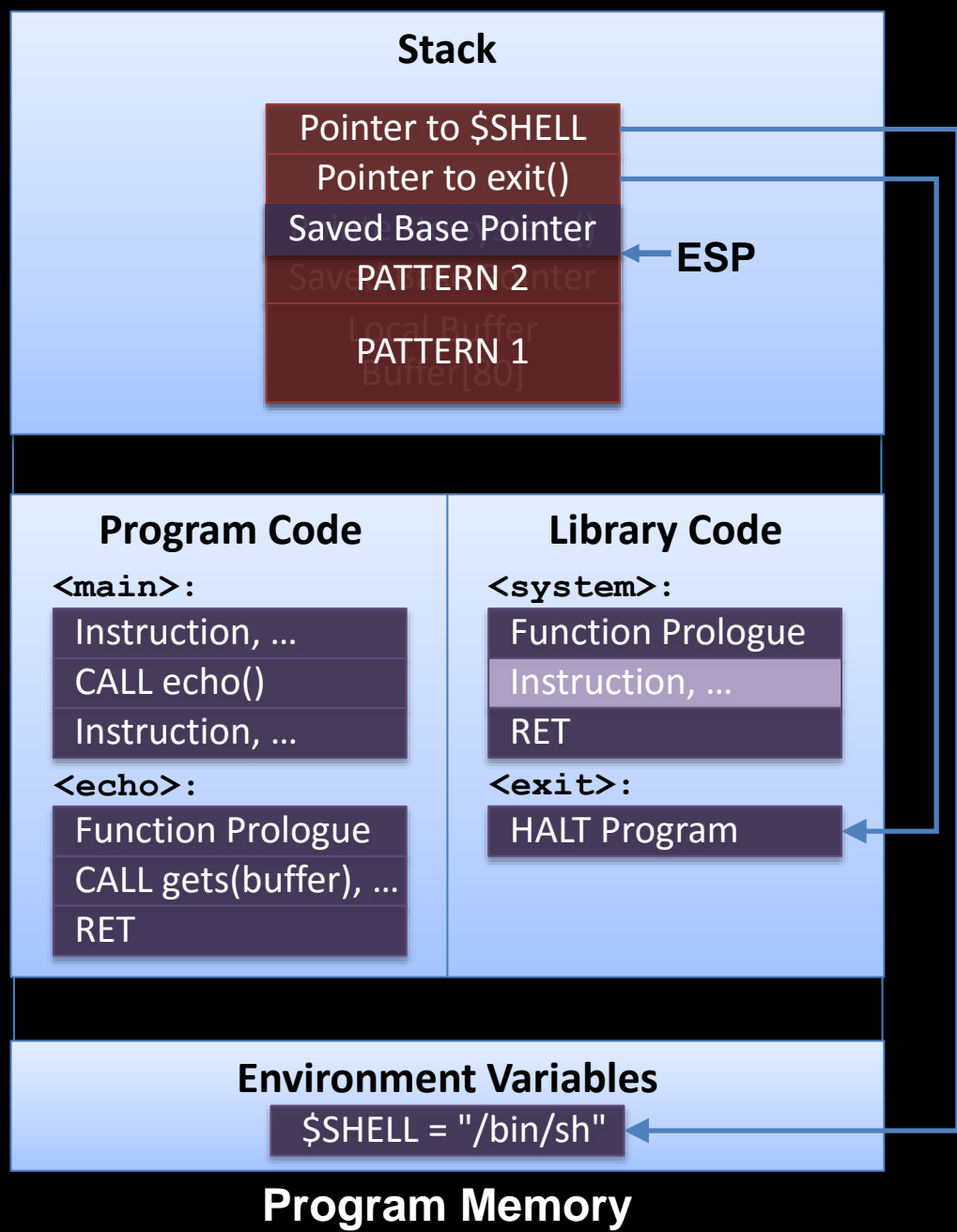



**system ("/bin/sh")
returning**

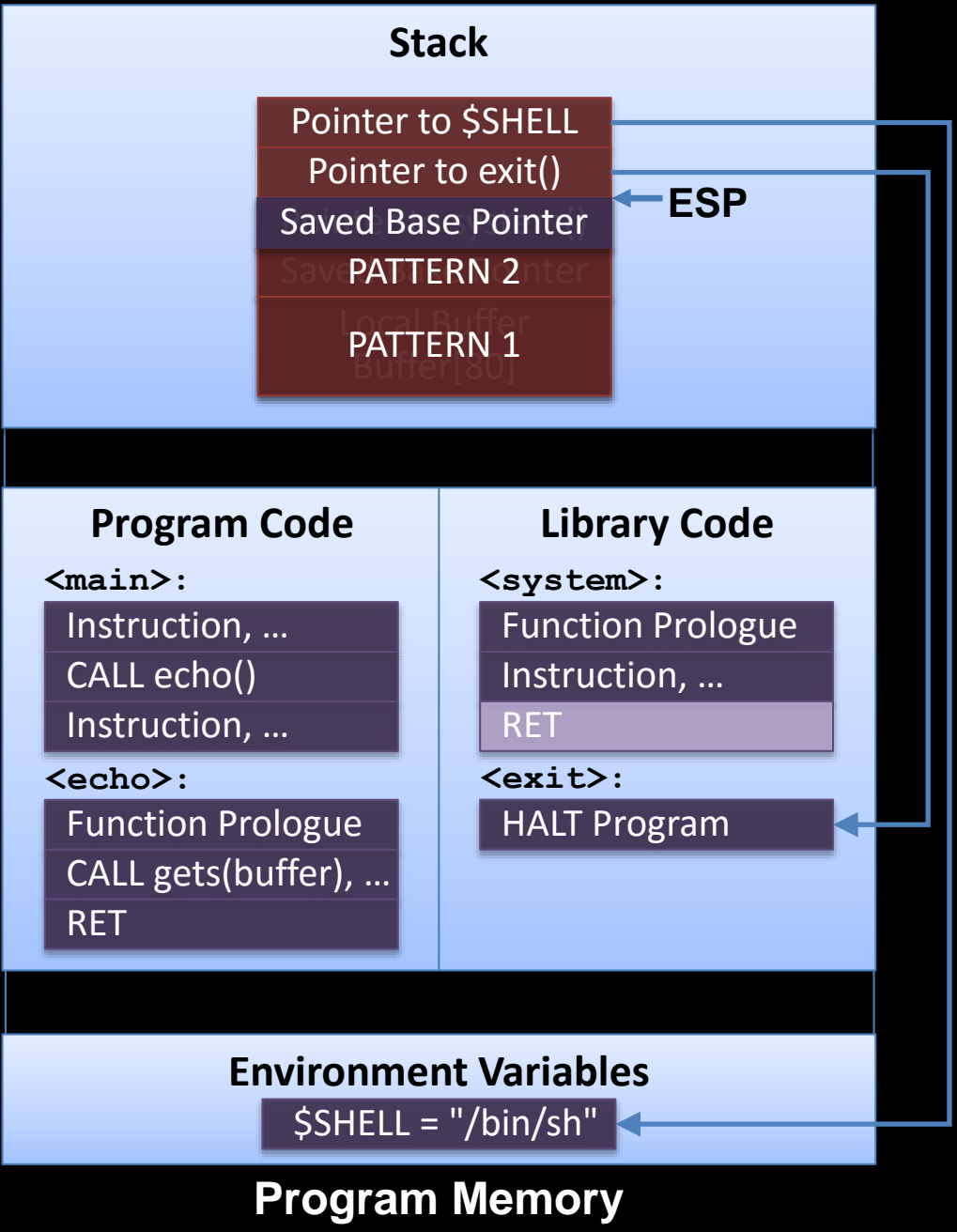

Adversary



Program
terminates

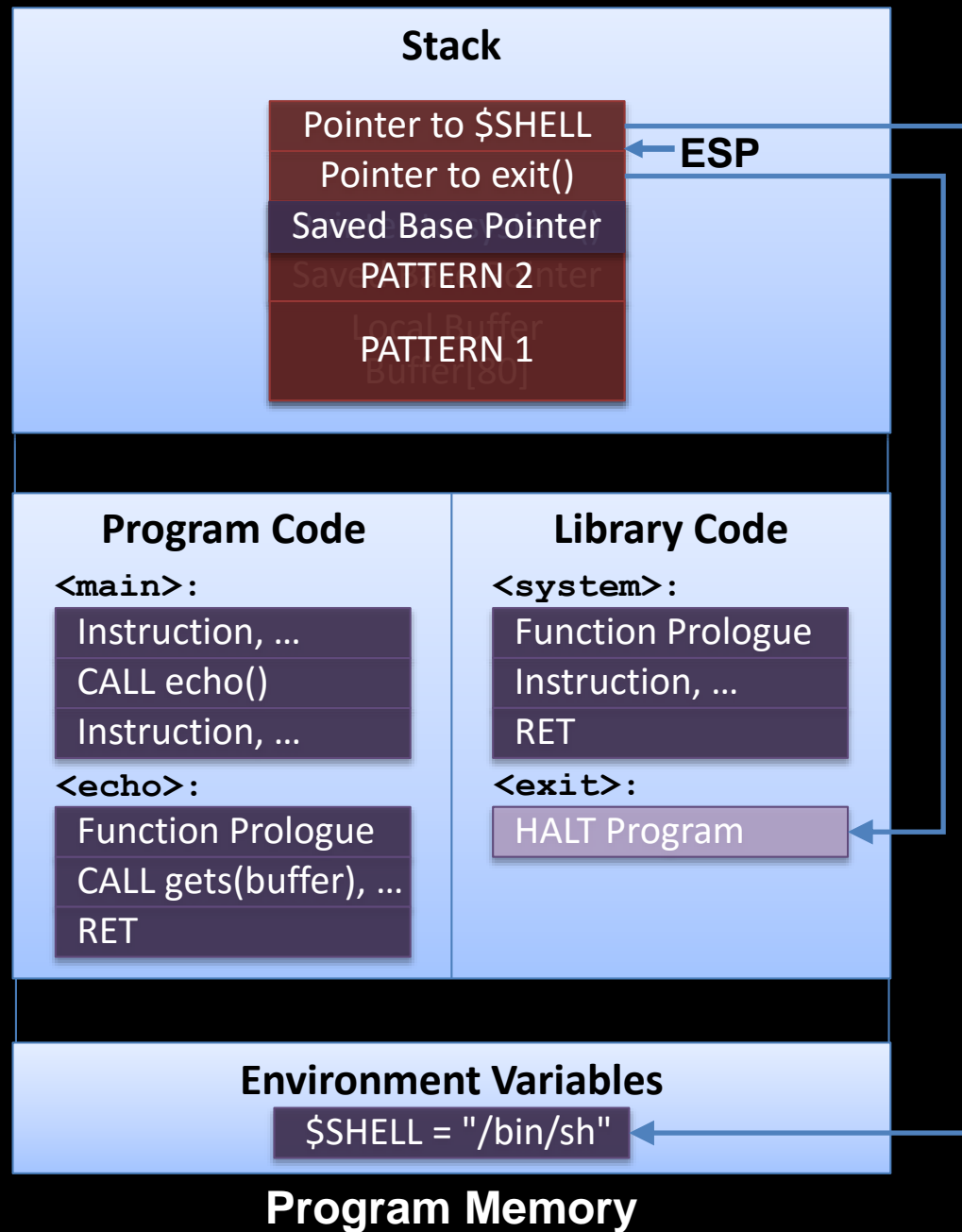

return-into-libc on ARM

- ◆ The first four function arguments are passed via registers
- ◆ Hence, how do we initialize the arguments before calling `system()` ?
 - ◆ We return to an instruction sequence that loads the argument from the stack

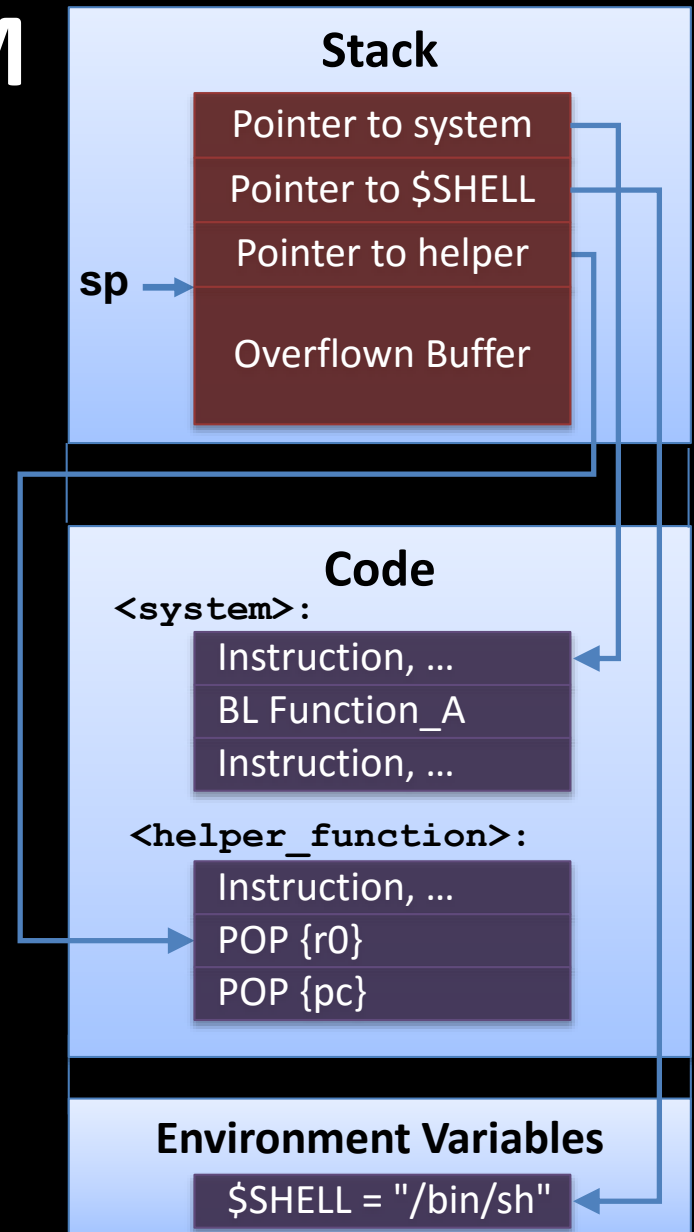

Limitations

- ◆ No branching, i.e., no arbitrary code execution
- ◆ Critical functions can be eliminated or wrapped

**Generalization of return-into-libc
attacks:
return-oriented programming (ROP)
[Shacham, ACM CCS 2007]**

ROP Adversary Model/Assumption

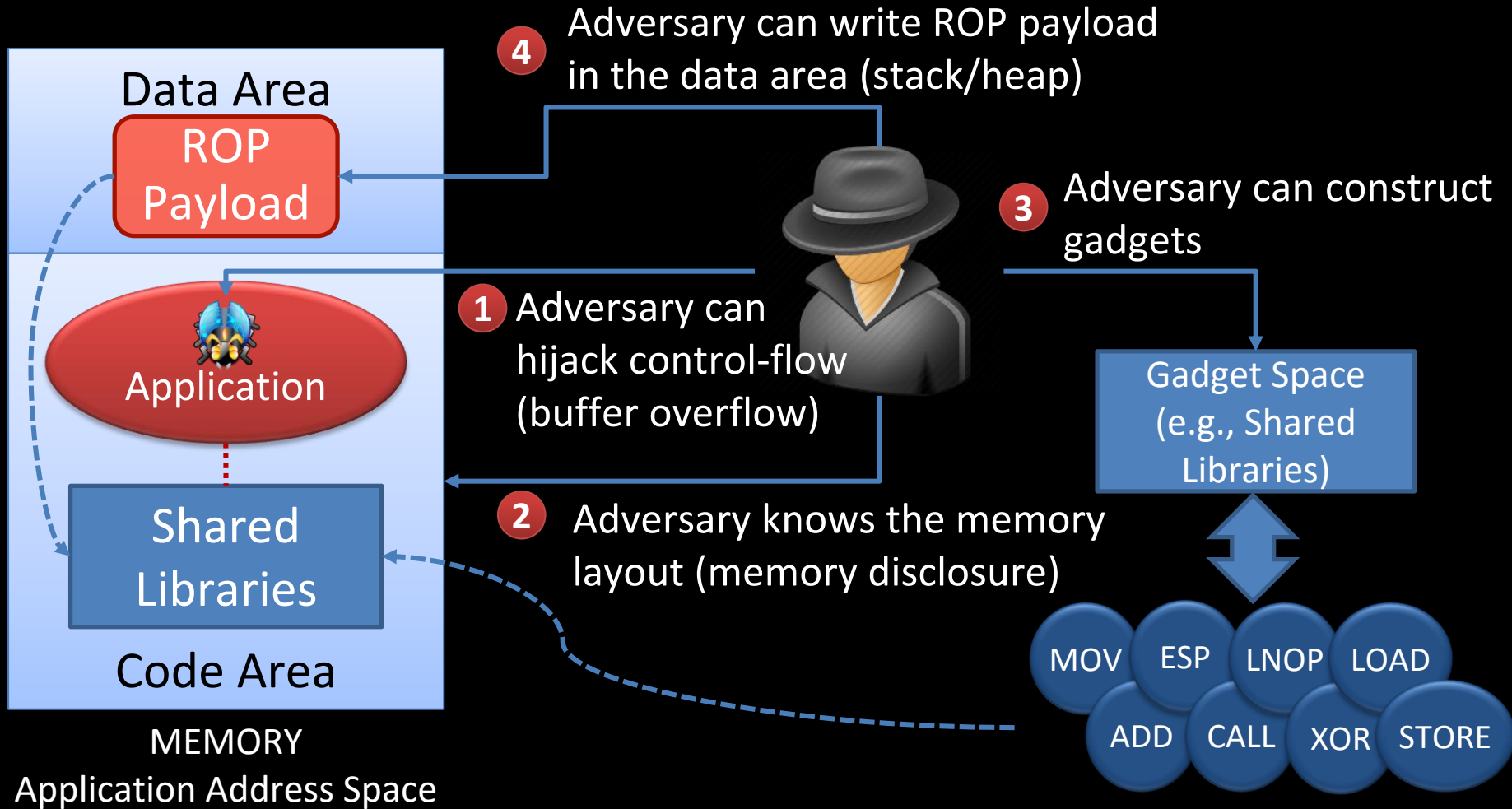

ROP Attack Technique: Overview

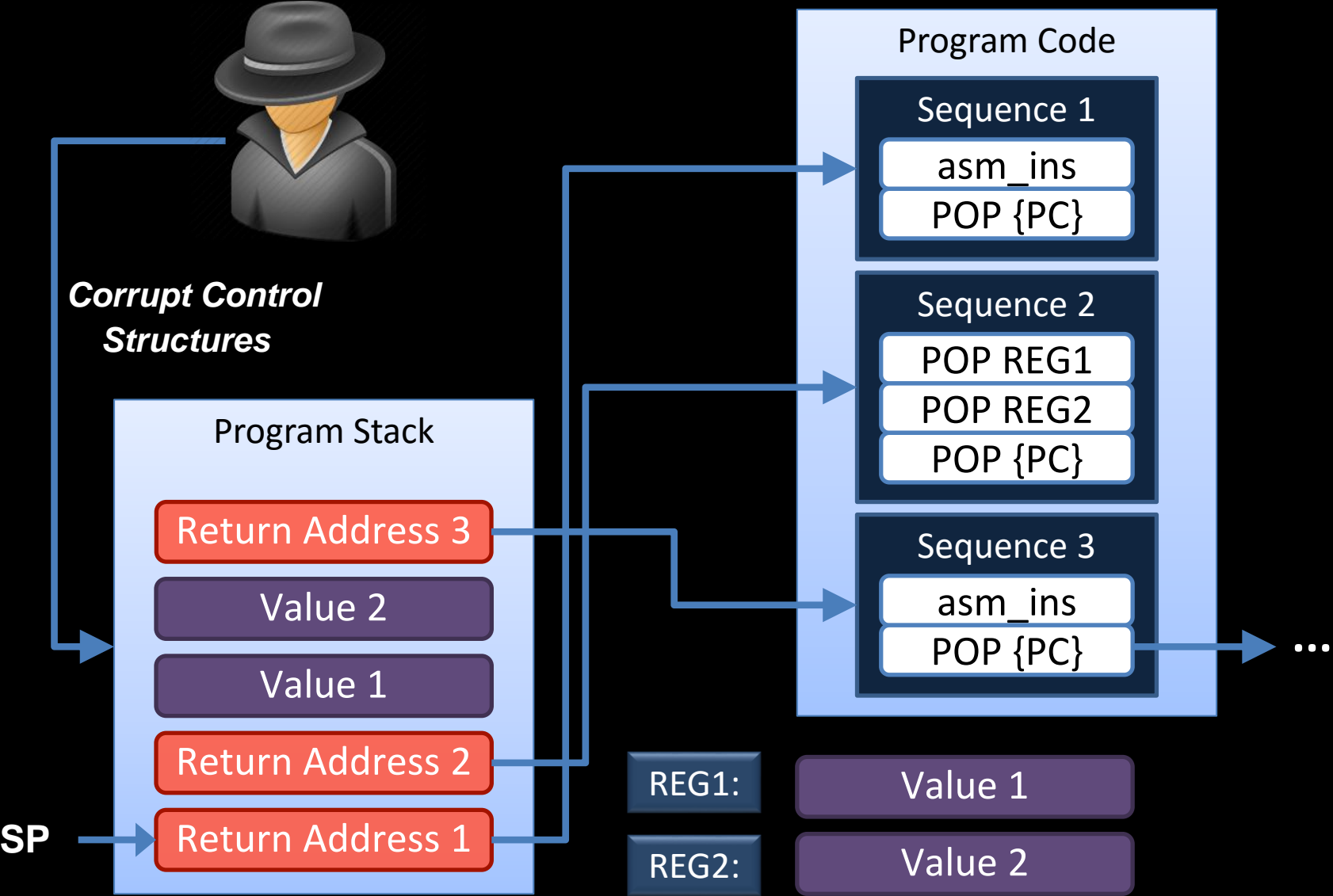

Summary of Basic Idea

- ◆ Perform arbitrary computation with return-into-libc techniques
- ◆ Approach
 - ◆ Use **small instruction sequences** (e.g., of libc) instead of using whole functions
 - ◆ Instruction sequences range from 2 to 5 instructions
 - ◆ All sequences end with a **return (POP{PC})** instruction
 - ◆ Instruction sequences are chained together to a **gadget**
 - ◆ A gadget performs a particular task (e.g., load, store, xor, or branch)
 - ◆ Afterwards, the adversary enforces his desired actions by combining the gadgets

Special Aspects of ROP

Code Base and Turing-Completeness

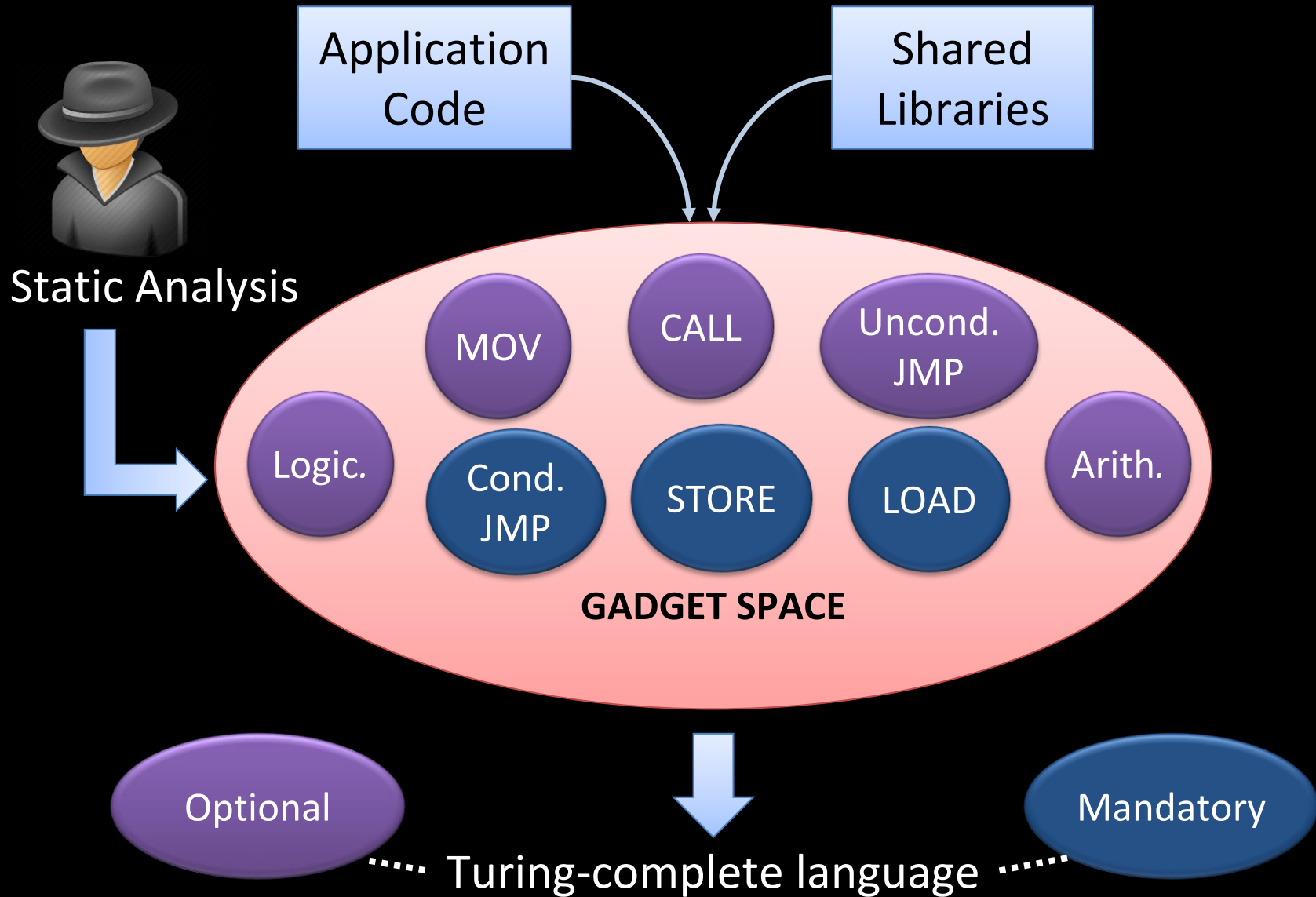

Gadget Space on Different Architectures

Architectures with no memory alignment, e.g., Intel x86

Architectures with memory alignment, e.g., SPARC, ARM

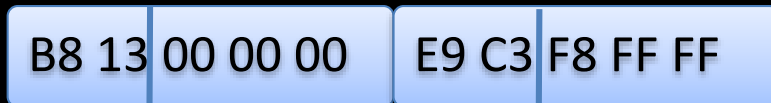
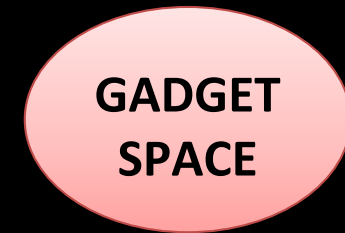
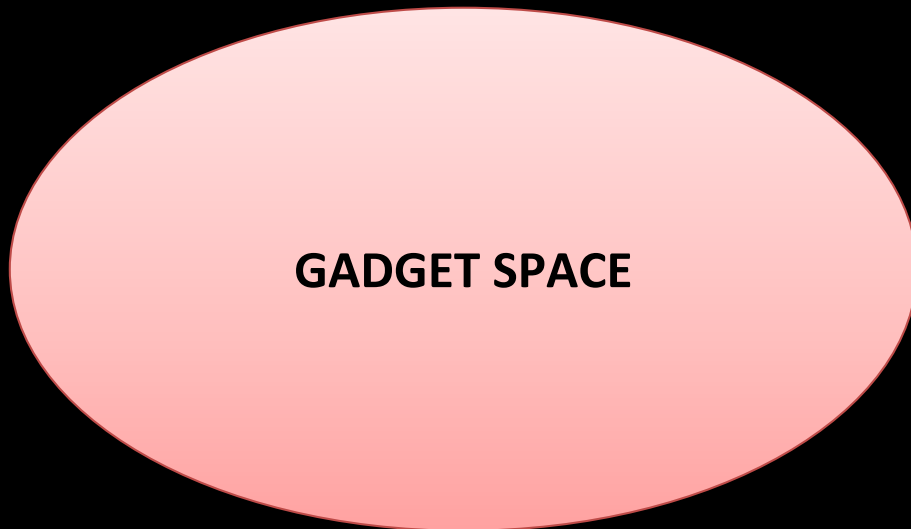

Intended Code

```
mov $0x13, %eax  
jmp 3aae9
```

Unintended Code

```
add %a1, (%eax)  
add %ch, %c1  
ret
```

Stack Pivot

[Zovi, RSA Conference 2010]

- ♦ Stack pointer plays an important role
 - ♦ It operates as an instruction pointer in ROP attacks
- ♦ Challenge
 - ♦ In order to launch a ROP exploit based on a heap overflow, we need to set the stack pointer to point to the heap
 - ♦ This is achieved by a **stack pivot**

Stack Pivot in Detail

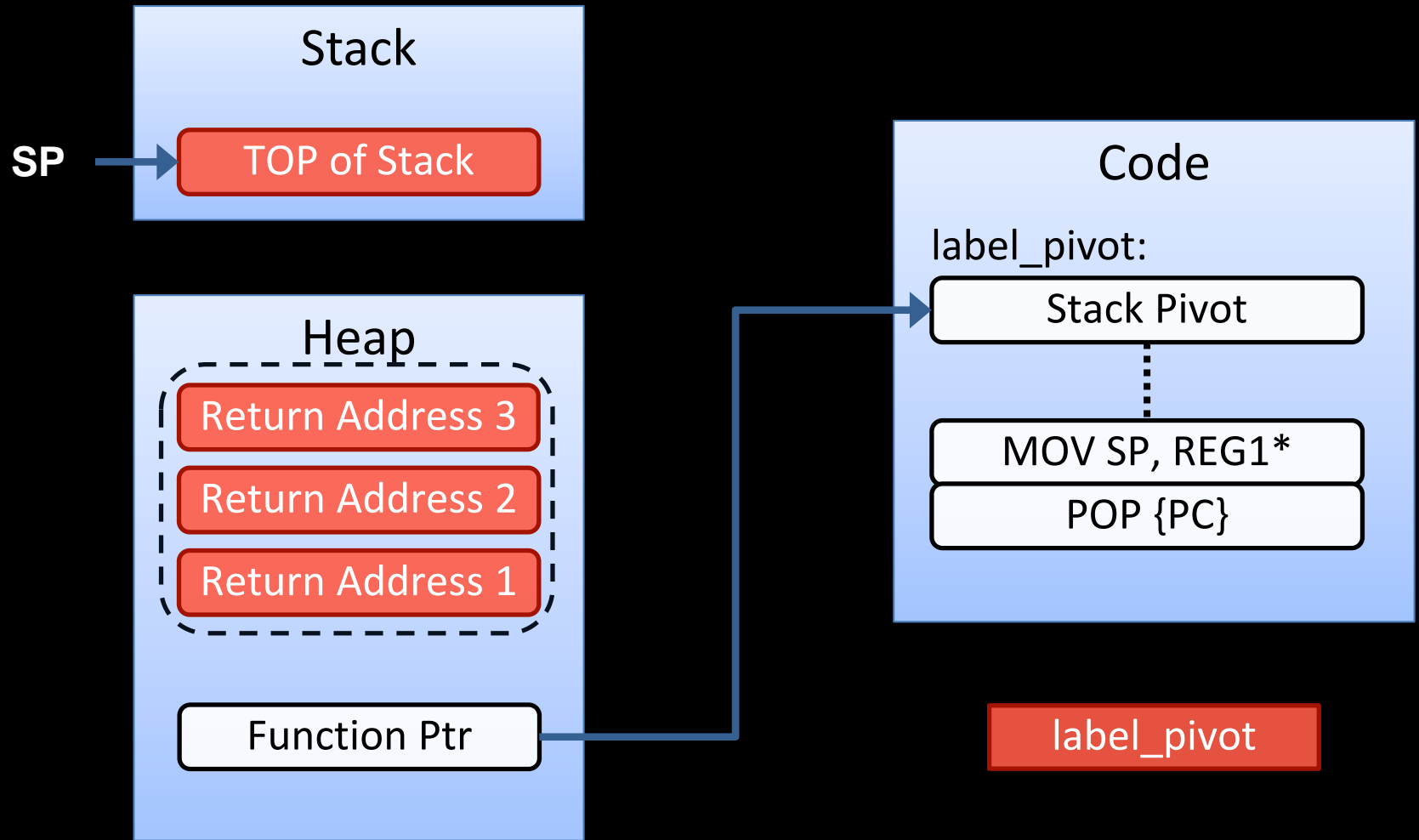

*REG1 is controlled by the adversary and holds beginning of ROP payload

ROP Variants

- ♦ Motivation: return address protection (shadow stack)
 - ♦ Validate every return (intended and unintended) against valid copies of return addresses
[Davi et al., AsiaCCS 2011]
- ♦ Exploit indirect jumps and calls
 - ♦ ROP without returns
[Checkoway et al., ACM CCS 2010]

CURRENT RESEARCH

SELECTED

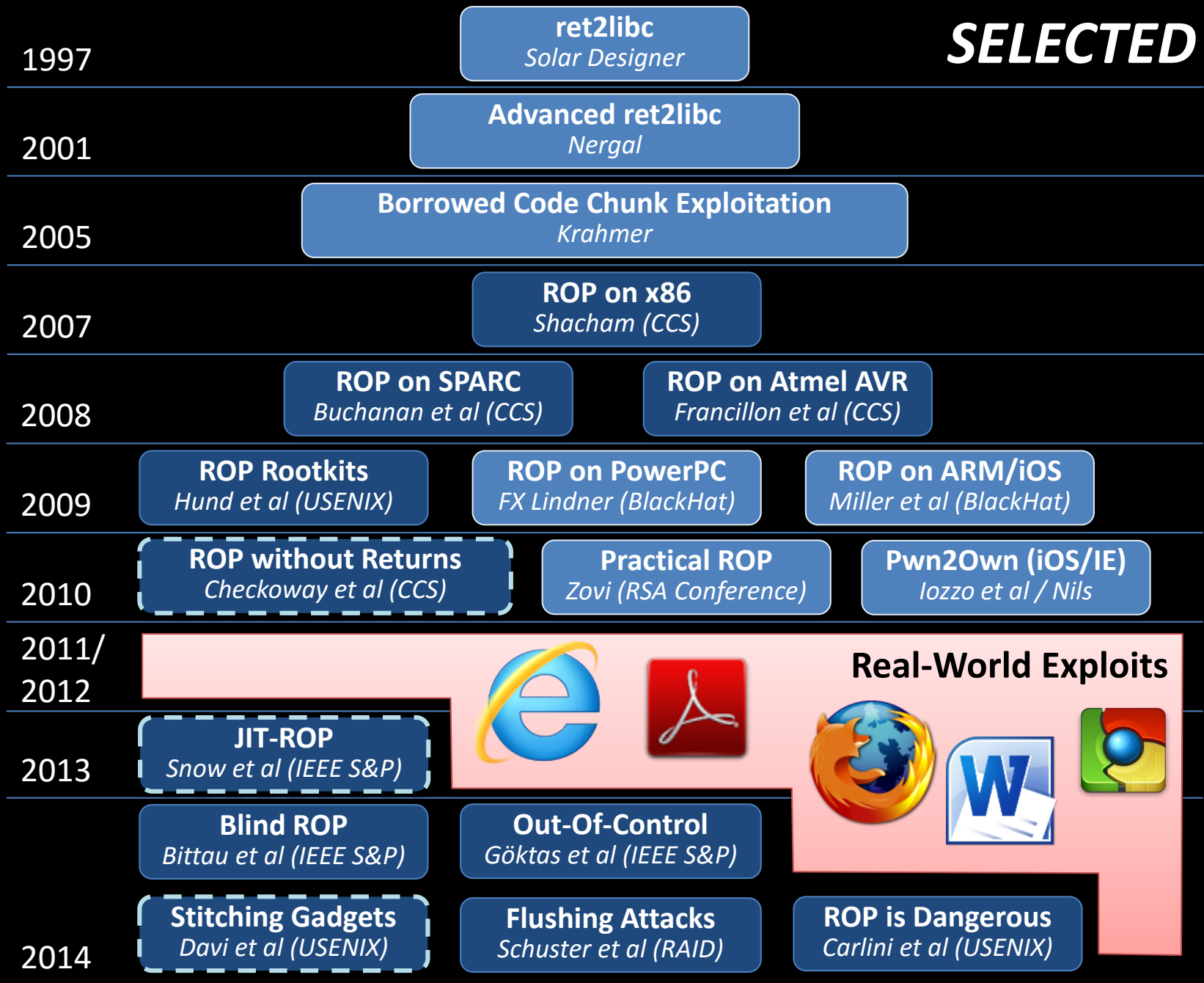

Our Work & Involvement

♦ Attacks

- ♦ Return-Oriented Programming without Returns [CCS 2010]
- ♦ Privilege Escalation Attacks on Android [ISC 2010]
- ♦ Just-In-Time Return-oriented Programming (JIT-ROP) [IEEE S&P 2013, Best Student Paper] & [BlackHat USA 2013]
- ♦ Stitching the Gadgets [USENIX Security 2014] & [BlackHat USA 2014]
- ♦ COOP [IEEE Security & Privacy 2015]
- ♦ Losing Control [CCS 2015]

♦ Detection & Prevention

- ♦ ROPdefender [AsiaCCS 2011]
- ♦ Mobile Control-Flow Integrity (MoCFI) [NDSS 2012]
- ♦ XIFER: Fine-Grained ASLR [AsiaCCS 2013]
- ♦ Filtering ROP Payloads [RAID 2013]
- ♦ Isomeron [NDSS 2015]
- ♦ Readactor [IEEE Security & Privacy 2015]
- ♦ HAFIX: Fine-Grained CFI in Hardware [DAC 2014, DAC 2015]
- ♦ Readactor++ [CCS 2015]



In this lecture

Main Defense Techniques

(Fine-grained) Code Randomization

[Cohen 1993 & Larsen et al., SoK IEEE S&P 2014]

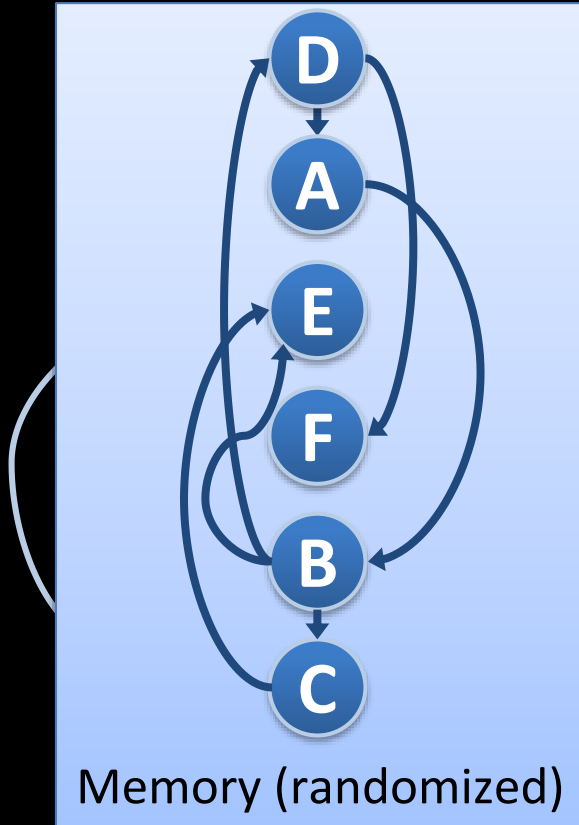

Control-Flow Integrity (CFI)

[Abadi et al., CCS 2005 & TISSEC 2009]

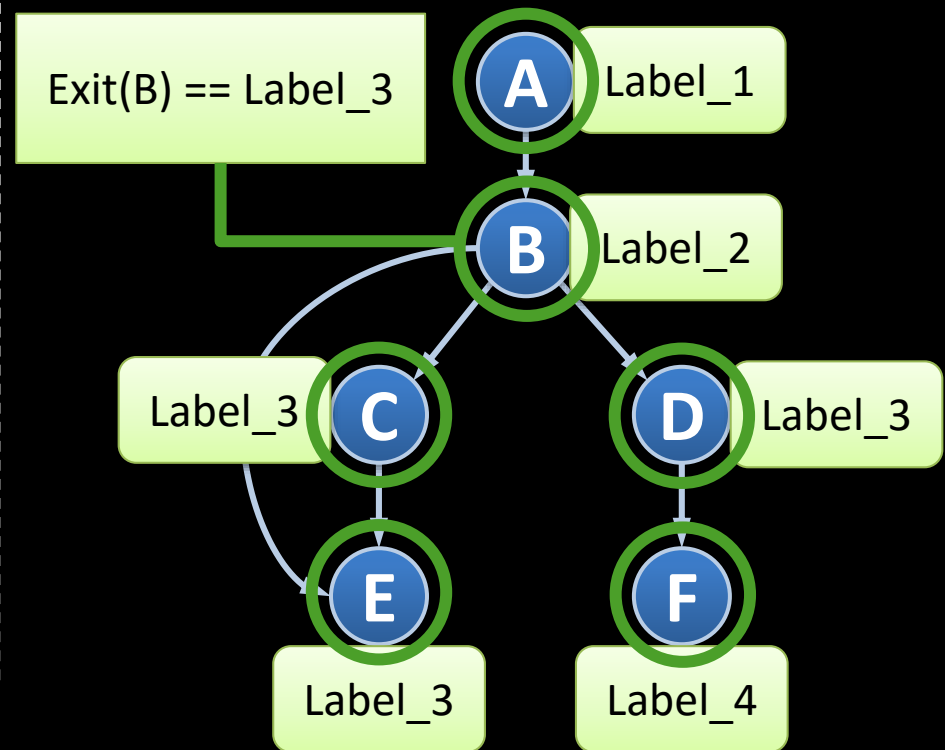

ASLR – Address Space Layout Randomization



Basics of Code Randomization

- ASLR randomizes the base address of code/data segments

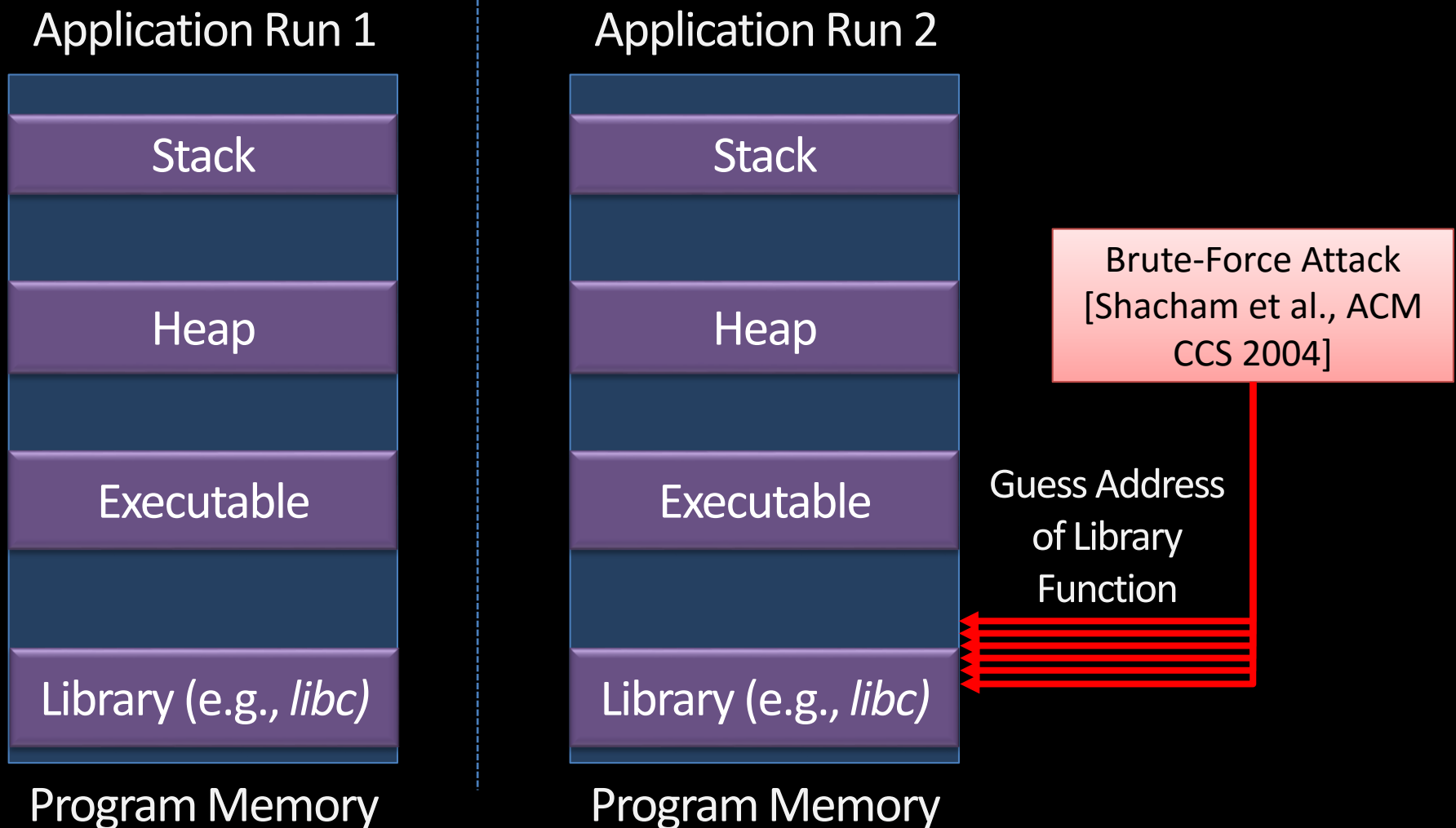

Basics of Memory Randomization

- ASLR randomizes the base address of code/data segments

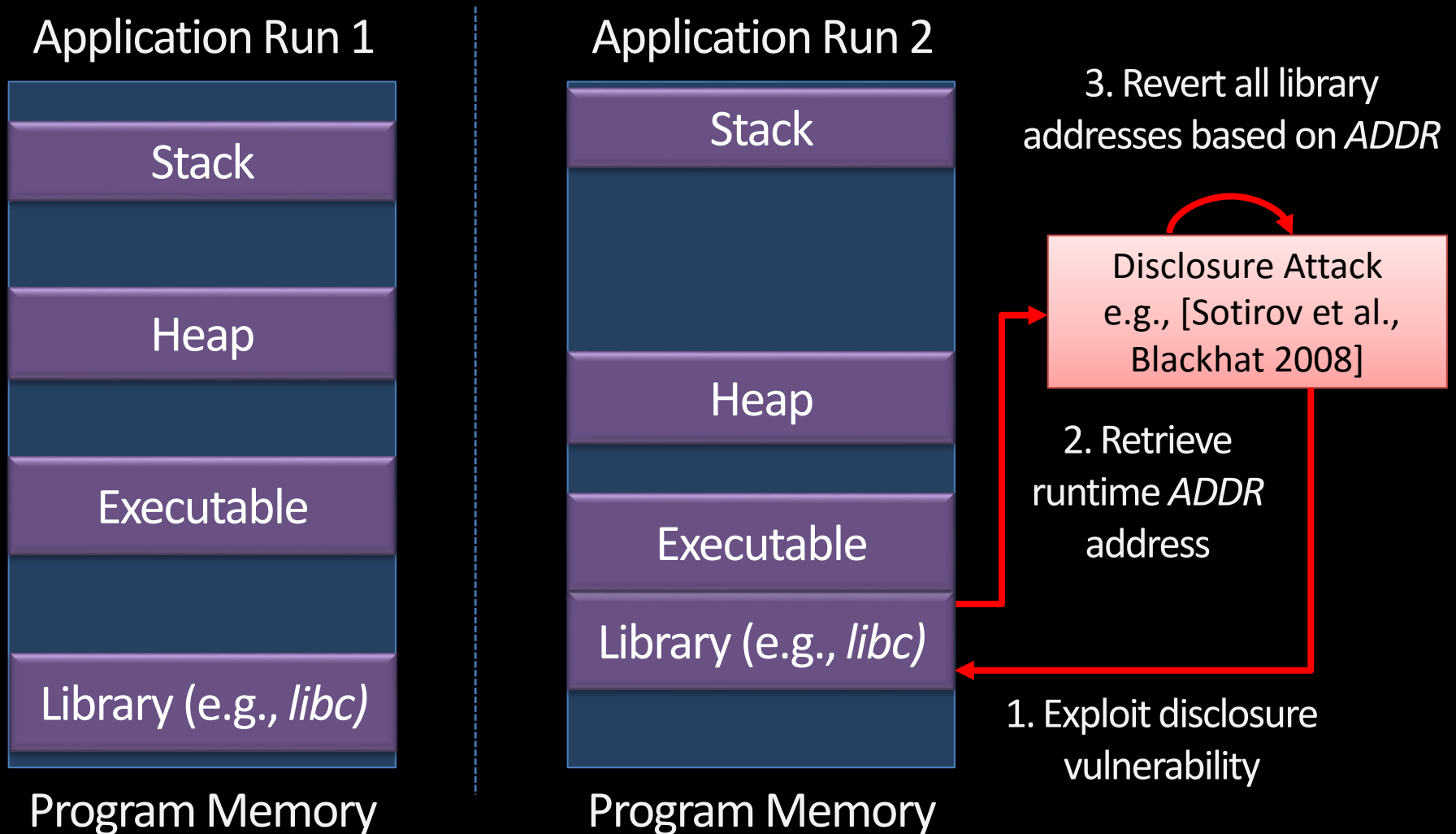

Fine-Grained ASLR

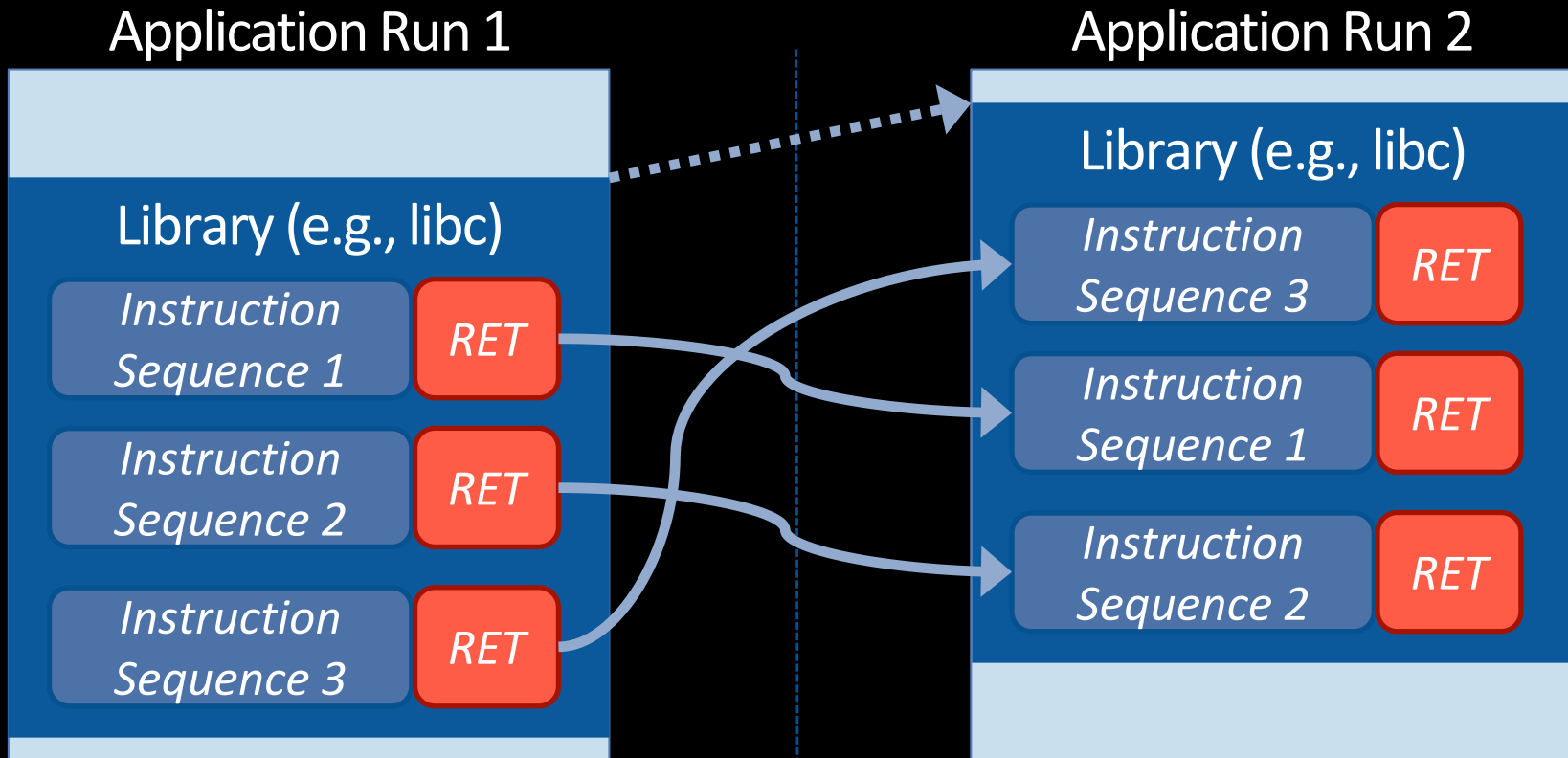

- ♦ **ORP** [Pappas et al., IEEE S&P 2012]: Instruction reordering/substitution within a BBL
- ♦ **ILR** [Hiser et al., IEEE S&P 2012]: Randomizing each instruction's location
- ♦ **STIR** [Wartell et al., ACM CCS 2012] & **XIFER** [with Davi et al., AsiaCCS 2013]: Permutation of BBLs

Does Fine-Grained ASLR Provide a Viable Defense in the Long Run?



Just-In-Time Code Reuse: On the Effectiveness of Fine-Grained
Address Space Layout Randomization

IEEE Security and Privacy Best Student Paper 2013

Kevin Z. Snow (UNC Chapel Hill), Lucas Davi, Alexandra
Dmitrienko, Christopher Liebchen, Fabian Monrose (UNC
Chapel Hill), Ahmad-Reza Sadeghi

Contributions

1

A novel ROP attack that undermines fine-grained ASLR

2

We show that memory disclosures are far more damaging than previously believed

3

A prototype exploit framework that demonstrates one instantiation of our idea, called JIT-ROP

High-Level Idea

Scripting Engine



Code Pointer

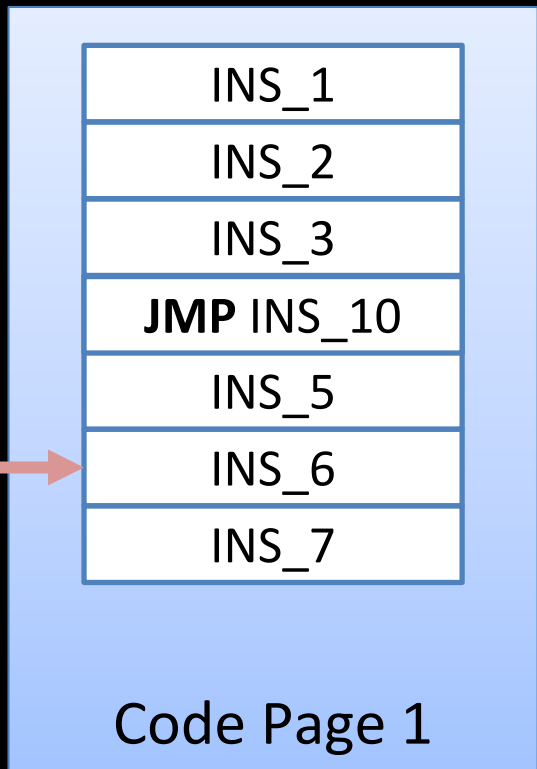
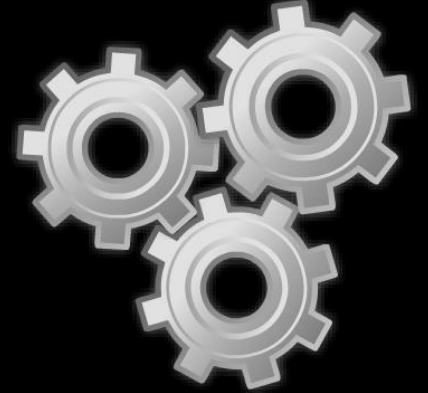

Page Start

4KB

Page End

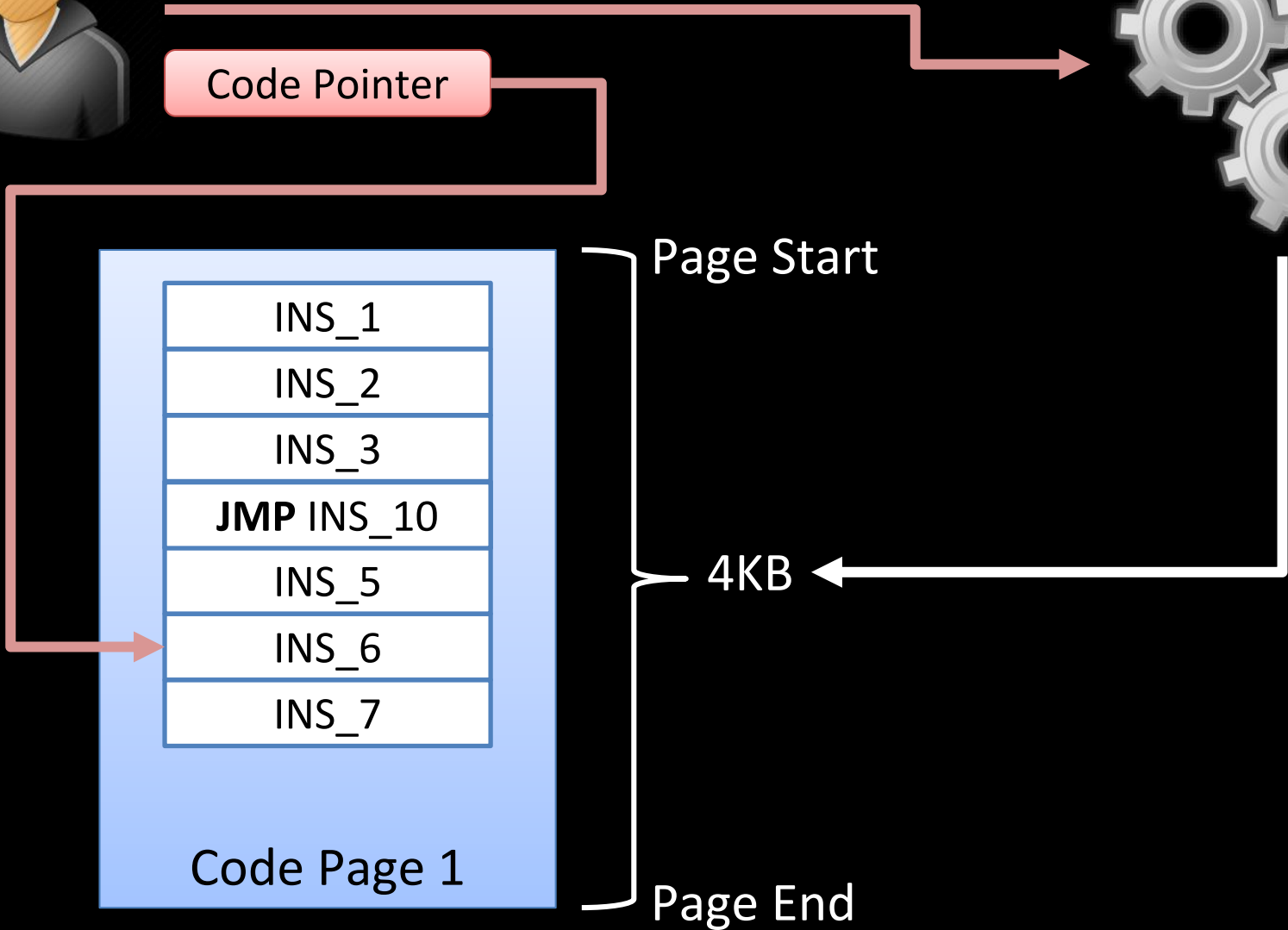

High-Level Idea

Scripting Engine



Code Pointer

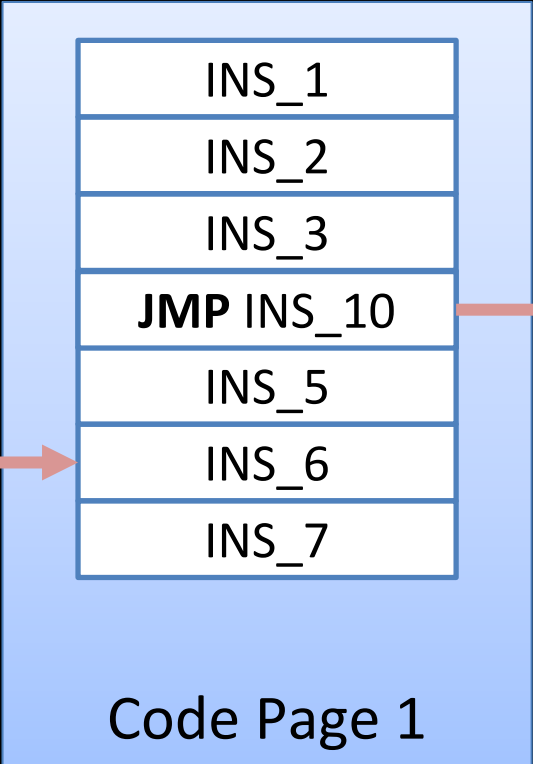
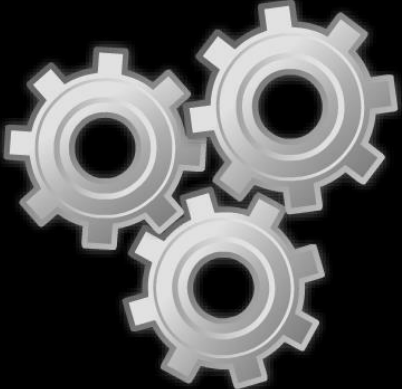

Page End

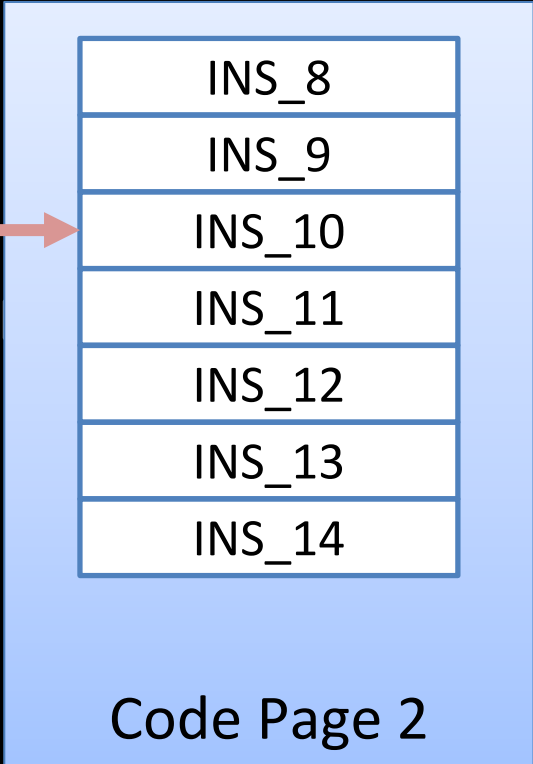

Applying JIT-ROP to Internet Explorer 8

- ◆ We applied JIT-ROP to a real-world vulnerability in IE 8
 - ◆ CVE-2012-1876: Heap overflow vulnerability
 - ◆ Within 7 seconds, our attack harvested code pages, identified and constructed useful ROP gadgets, and finally build and executed the payload



For more evaluation results and details check out our paper and BlackHat USA 2013 slides

Possible Defenses

Execute-only memory

Software-based:
Execute-no-Read

[Backes et al., ACM
CCS 2014]

Hardware-based:
Readactor

[with Crane et al.,
IEEE S&P 2015]

Execution-path randomization

Isomeron

[Davi et al., NDSS
2015]

Control-flow Integrity (CFI)

CFI does not rely
on any
randomization key

Control-Flow Integrity (CFI)

[Abadi et al., CCS 2005 & TISSEC 2009]

A general defense against code-reuse attacks

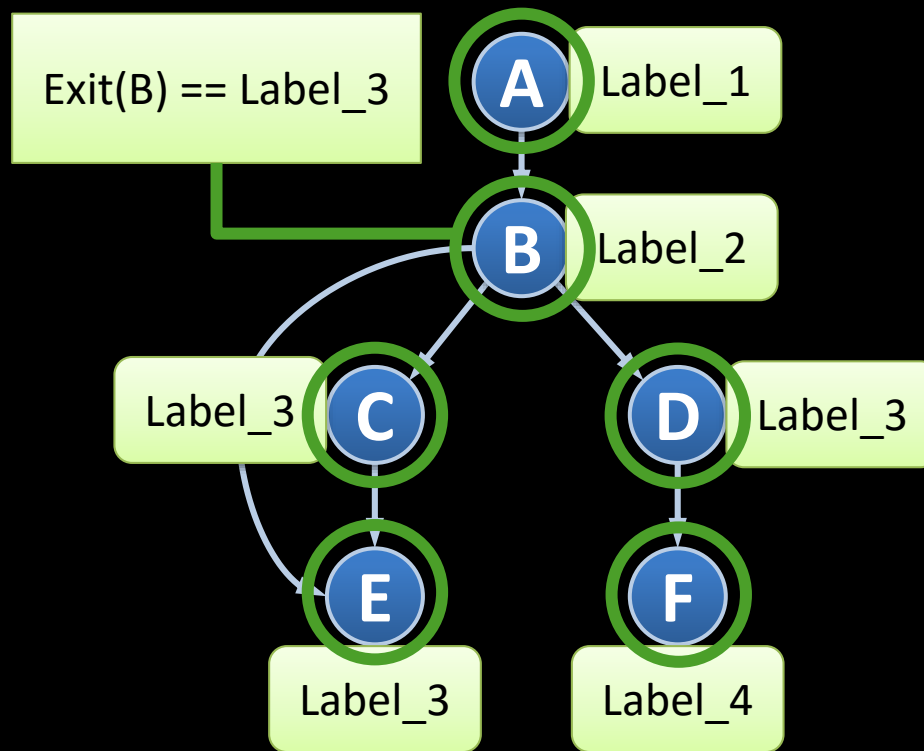

CFI Defense Literatur

SELECTED

2002

Program Shepherding
Kiriansky et al. (USENIX Sec.)

2005

Control-Flow Integrity (CFI)
Abadi et al. (CCS 2005)

2006

XFI
Abadi et al. (OSDI)

Architectural Support for CFI
Budiu et al. (ASID)

2010

HyperSafe
Wang et al. (IEEE S&P)

2011

CFI and Data Sandboxing
Zeng et al (CCS)

Control-Flow Locking
Bletch et al. (ACSAC)

2012

Branch Regulation
Kayaalp et al (ISCA)

Mobile CFI
Davi et al. (NDSS)

2013

Control-Flow Restrictor
Pewny et al (ACSAC)

kBouncer
Pappas et al. (USENIX Sec.)

bin-CFI
Zhang et al. (USENIX Sec.)

CCFIR
Zhang et al. (IEEE S&P)

2014

ROPecker
Cheng et al. (NDSS)

Forward-Edge CFI
Tice et al. (USENIX Sec.)

SAFEDISPATCH
Jang et al. (NDSS)

Modular CFI
Niu et al. (PLDI)

RockJIT
Niu et al. (CCS)

HAFIX
Davi et al. (DAC)

Which Instructions to Protect?

Returns

- **Purpose:** Return to calling function
- **CFI Relevance:** Return address located on stack

Indirect Jumps

- **Purpose:** switch tables, dispatch to library functions
- **CFI Relevance:** Target address taken from either processor register or memory

Indirect Calls

- **Purpose:** call through function pointer, virtual table calls
- **CFI Relevance:** Target address taken from either processor register or memory

Label Granularity: Trade-Offs (1/2)

- Many CFI checks are required if unique labels are assigned per node

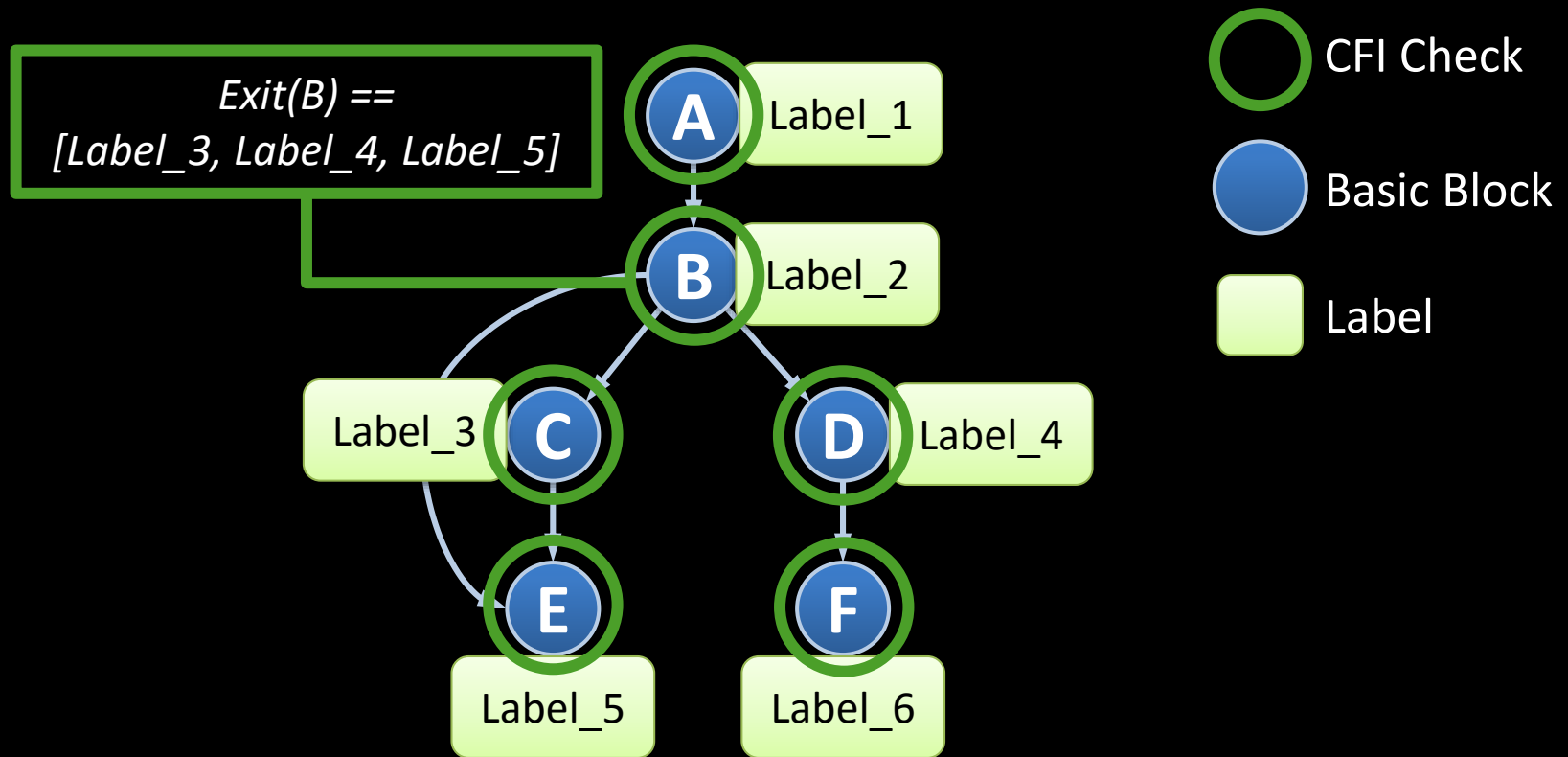

Label Granularity: Trade-Offs (2/2)

- ♦ Optimization step: Merge labels to allow single CFI check
- ♦ However, this allows for unintended control-flow paths

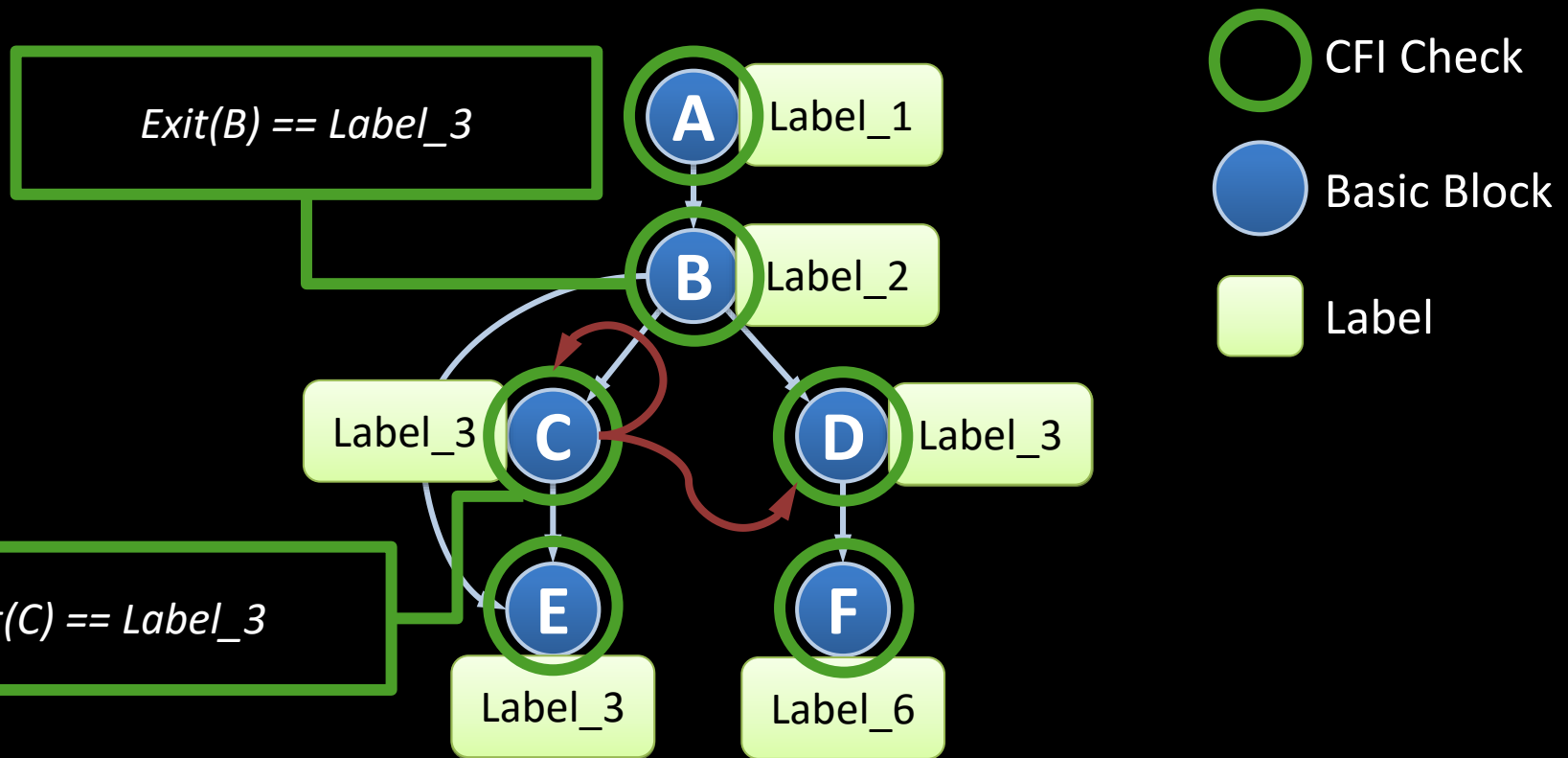

Label Problem for Returns

- ◆ **Static CFI label checking** leads to coarse-grained protection for returns
- ◆ **Shadow stack** allows for fine-grained return address protection but incurs higher overhead

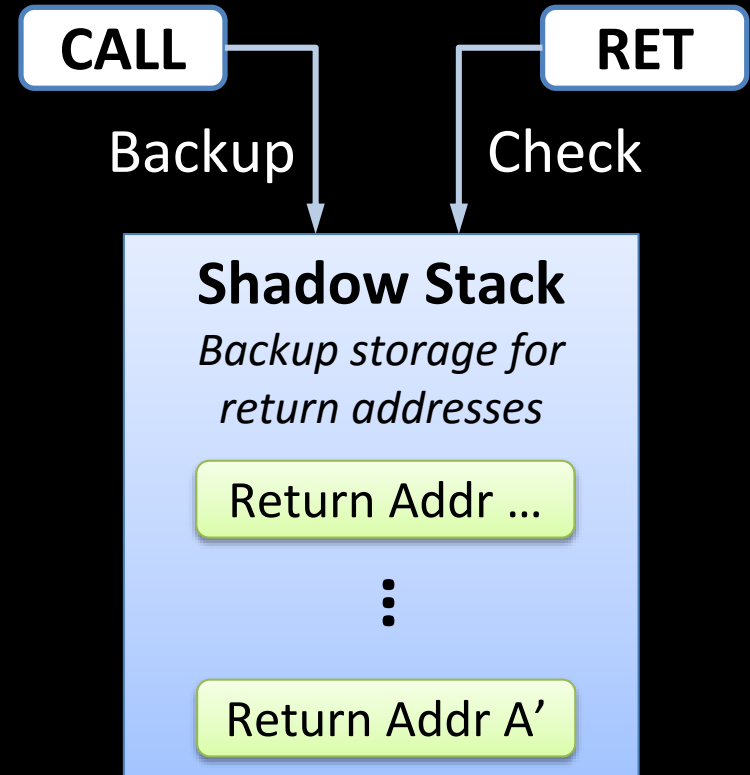
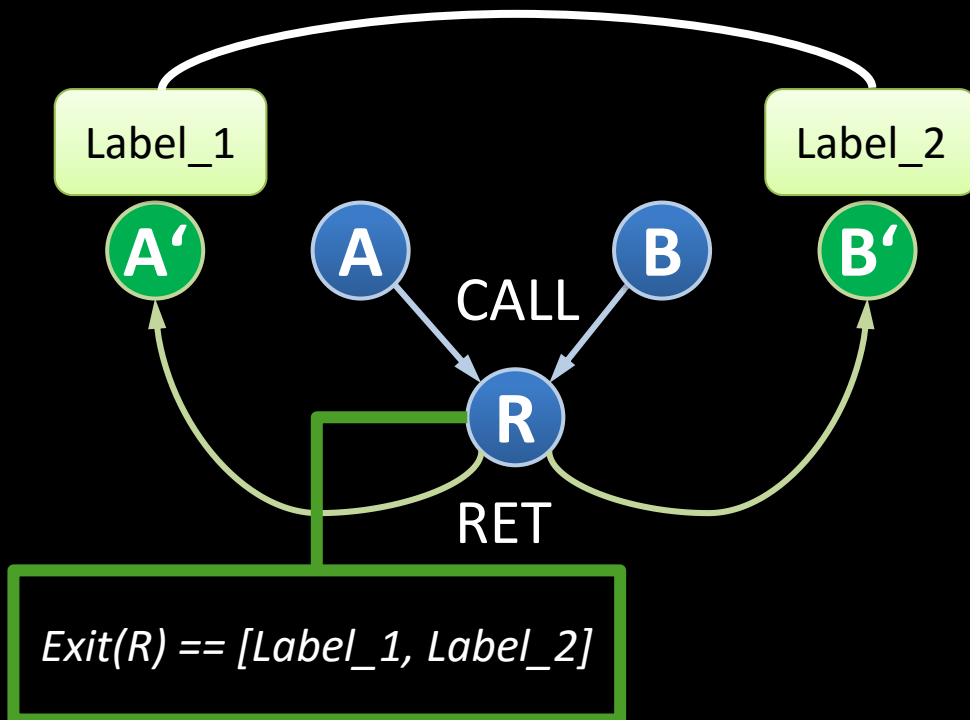

Original CFI: Benefits and Limitations

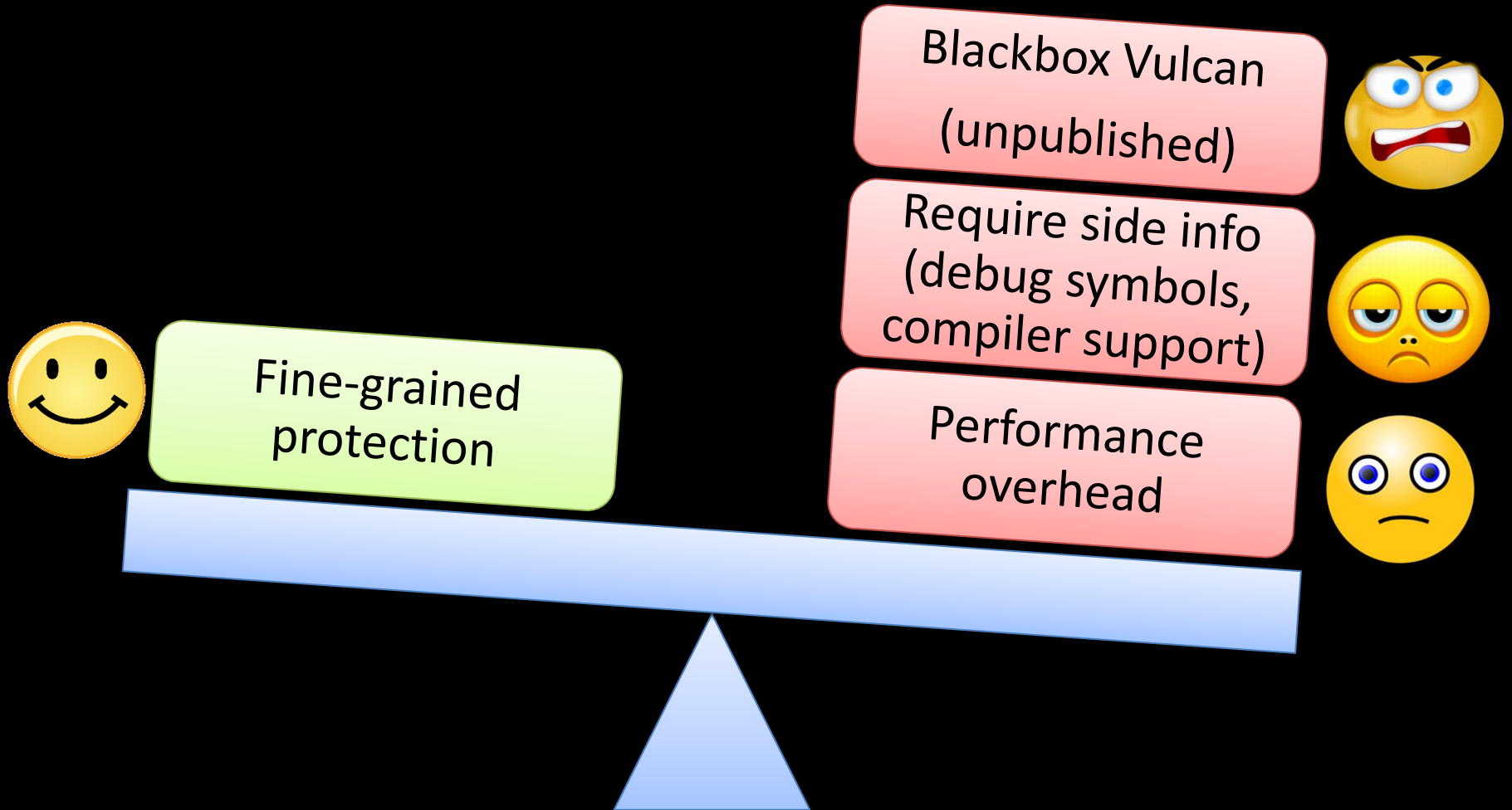

Hot Research Topic: “Practical” (coarse-grained) Control Flow Integrity (CFI)

Recently, many solutions proposed

CCFIR
[IEEE S&P'13]

MS
BlueHat
Prize

ROPecker
[NDSS'14]

MS
BlueHat
Prize

CFI for COTS
Binaries
[USENIX Sec'13]

kBouncer
[USENIX Sec'13]

ROPGuard
[Microsoft EMET]



EMET

[http://technet.microsoft.com/
en-us/security/jj653751](http://technet.microsoft.com/en-us/security/jj653751)

Open Question:

Practical and secure mitigation of code reuse attacks

Turing-completeness of return-oriented programming

Negative Result:

All current (published)
coarse-grained CFI solutions can be
bypassed

Big Picture

Systematic Security
Analysis of Coarse-
Grained CFI

Gadget
Analysis

Exploit
Development

CFI Policies

Frequency of CFI Checks

Deriving a CFI policy that
combines all schemes

Turing-complete
gadget set

Gadgets to
bypass heuristics



1. Systematic Security Analysis of Coarse-Grained CFI

Coarse-grained CFI leads to CFG imprecision

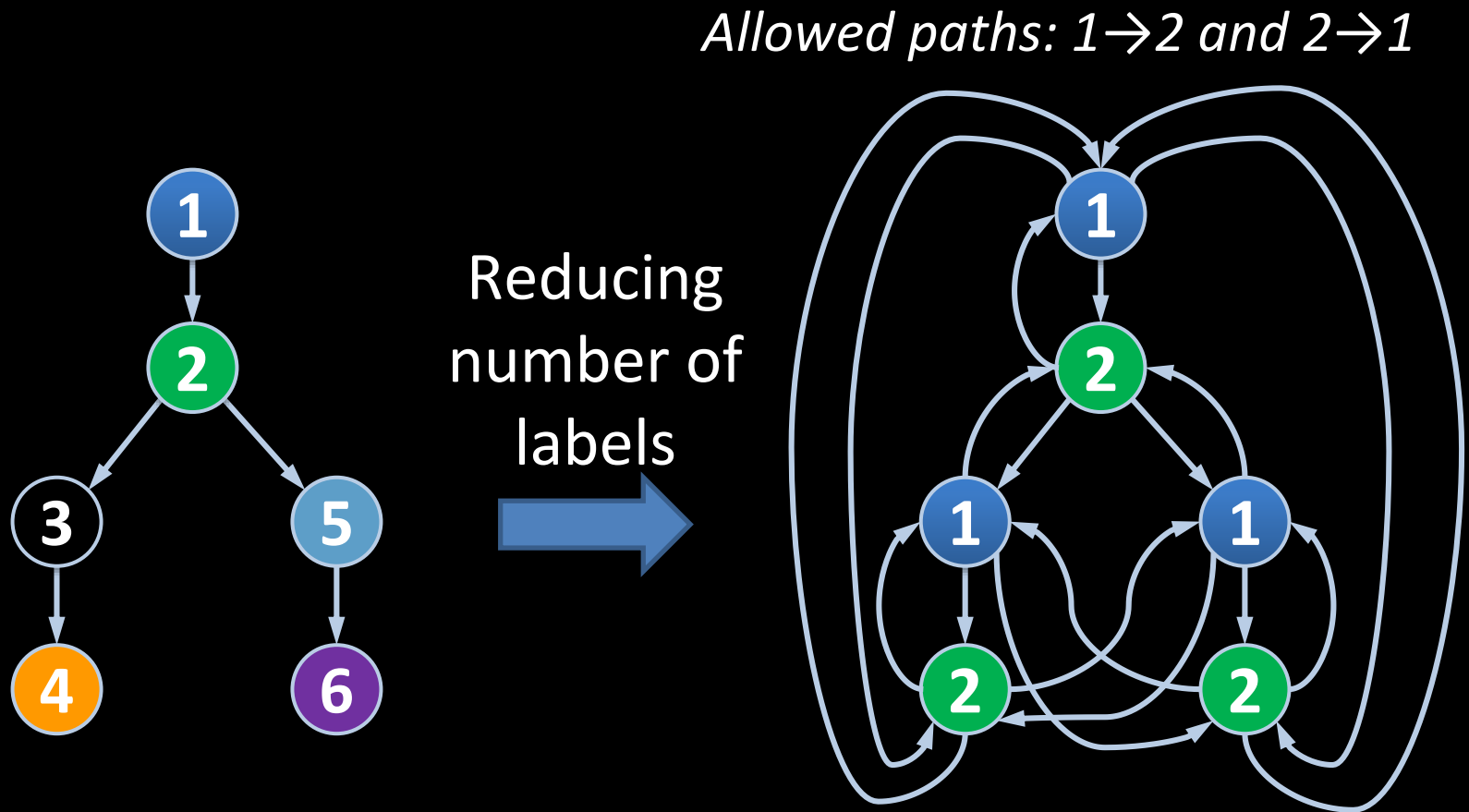

Main Coarse-Grained CFI Policies

- ◆ **CFI Policy 1: Call-Preceded Sequences**

- ◆ Returns need to target a call-preceded instruction
- ◆ **No shadow stack required**

- ◆ **CFI Policy 2: Behavioral-Based Heuristics**

- ◆ Prohibit a chain of **N** short sequences each consisting of less than **S** instructions

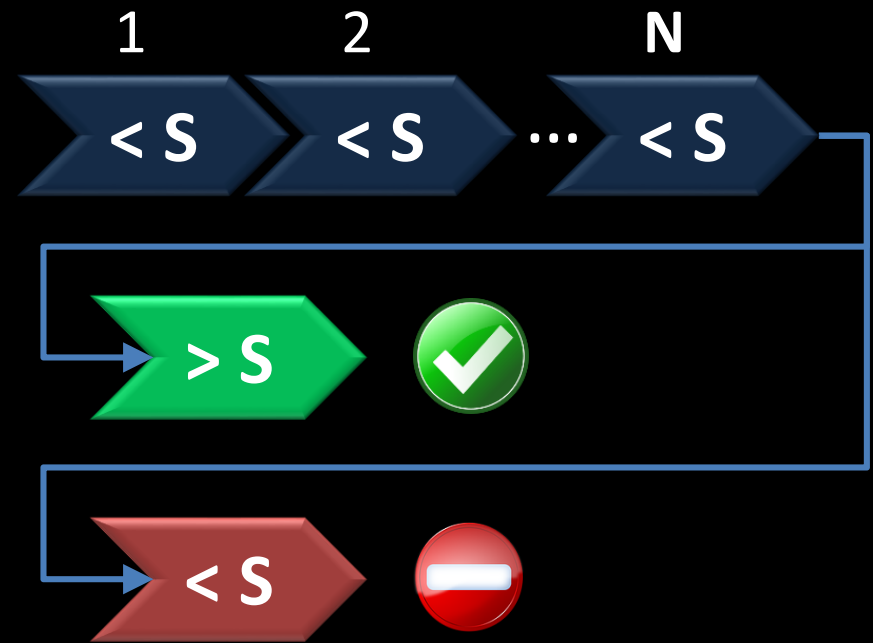
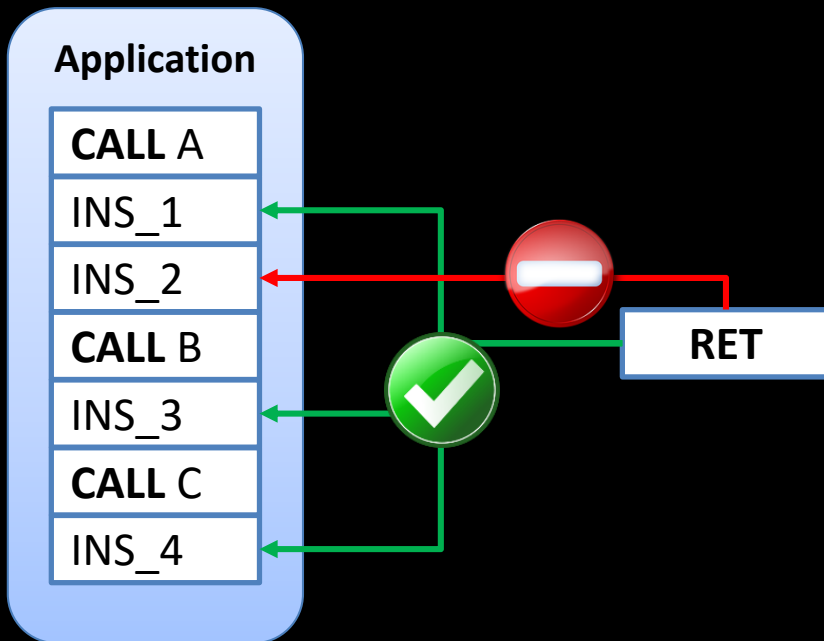

Coarse-Grained CFI Proposals

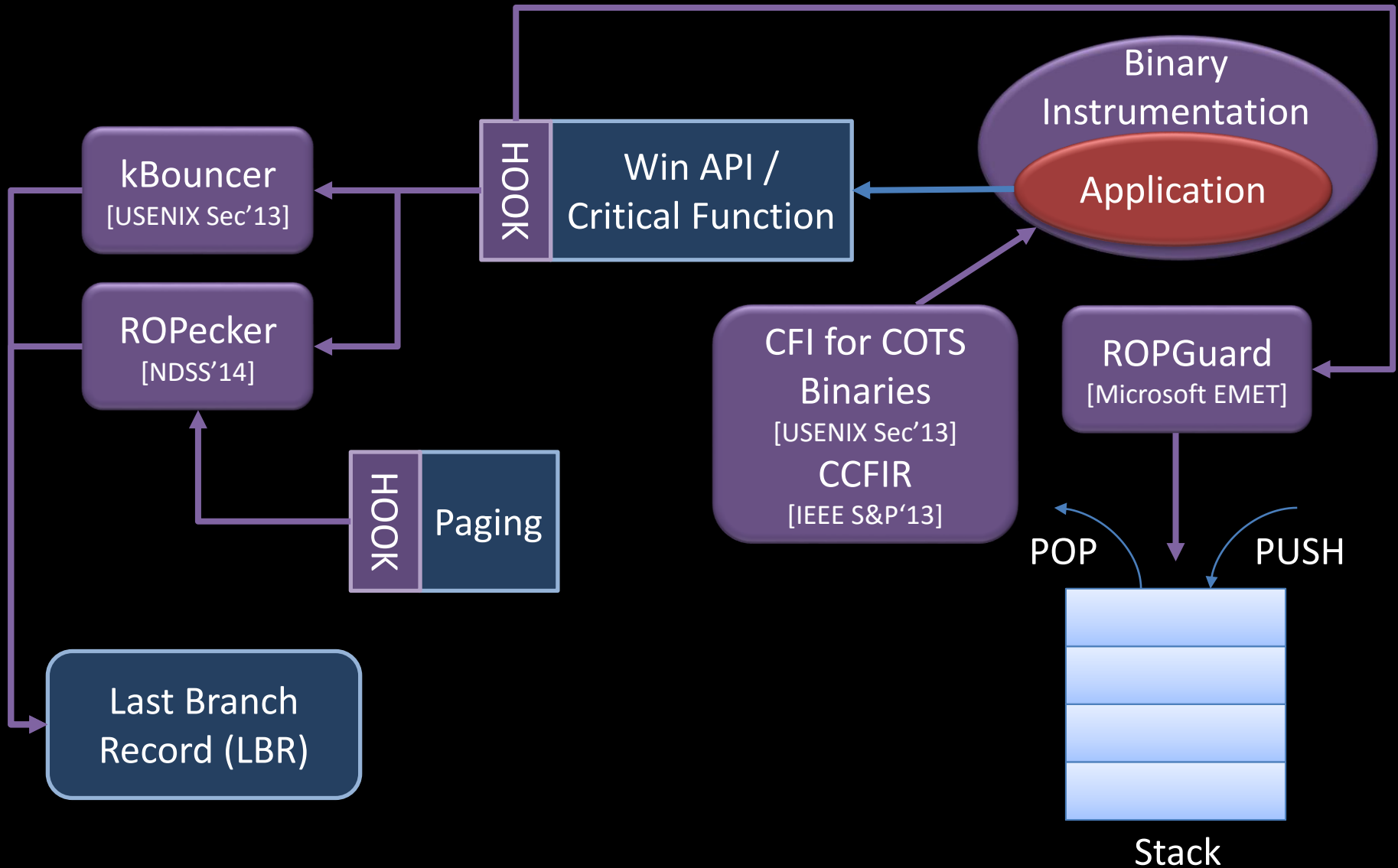

Deriving a Combined CFI Policy

CFI Policy	kBouncer [USENIX Sec. 2013]	ROPecker [NDSS 2014]	ROPGuard [Microsoft EMET]	CFI for COTS Binaries [USENIX Sec. 2013]	<i>Combined CFI Policy</i>
CFI Policy 1 <i>Call-Preceded Sequences</i>					
CFI Policy 2 <i>Behavioral-Based Heuristics</i>					
Time of CFI Check	WinAPI	2 Page Sliding Window/ Critical Functions	WinAPI/ Critical Functions	Indirect Branch	Any Time



No Restriction



CFI Policy

Here only the core policies shown. However, we consider all other deployed policies in our analysis.

2. Gadget Analysis

Methodology

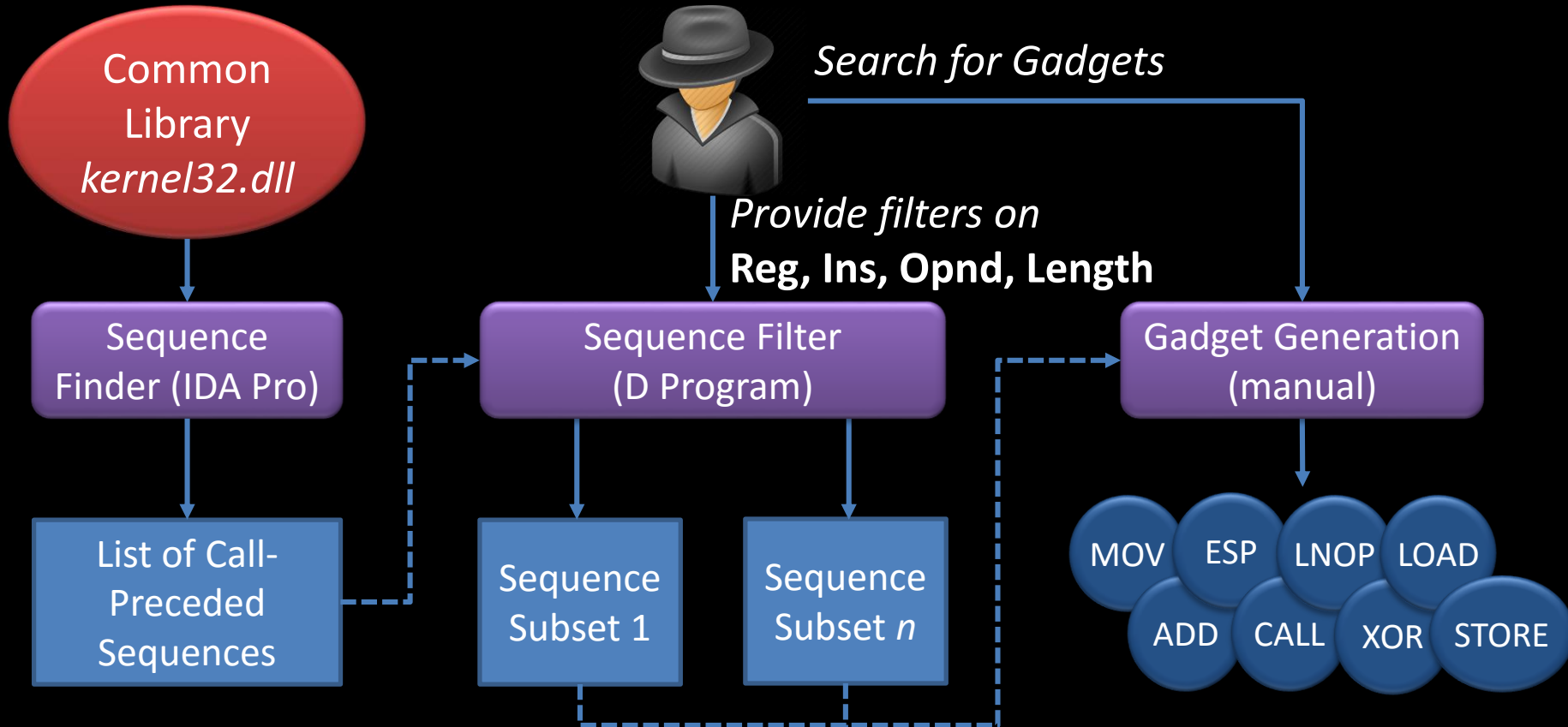

Long-NOP Gadget

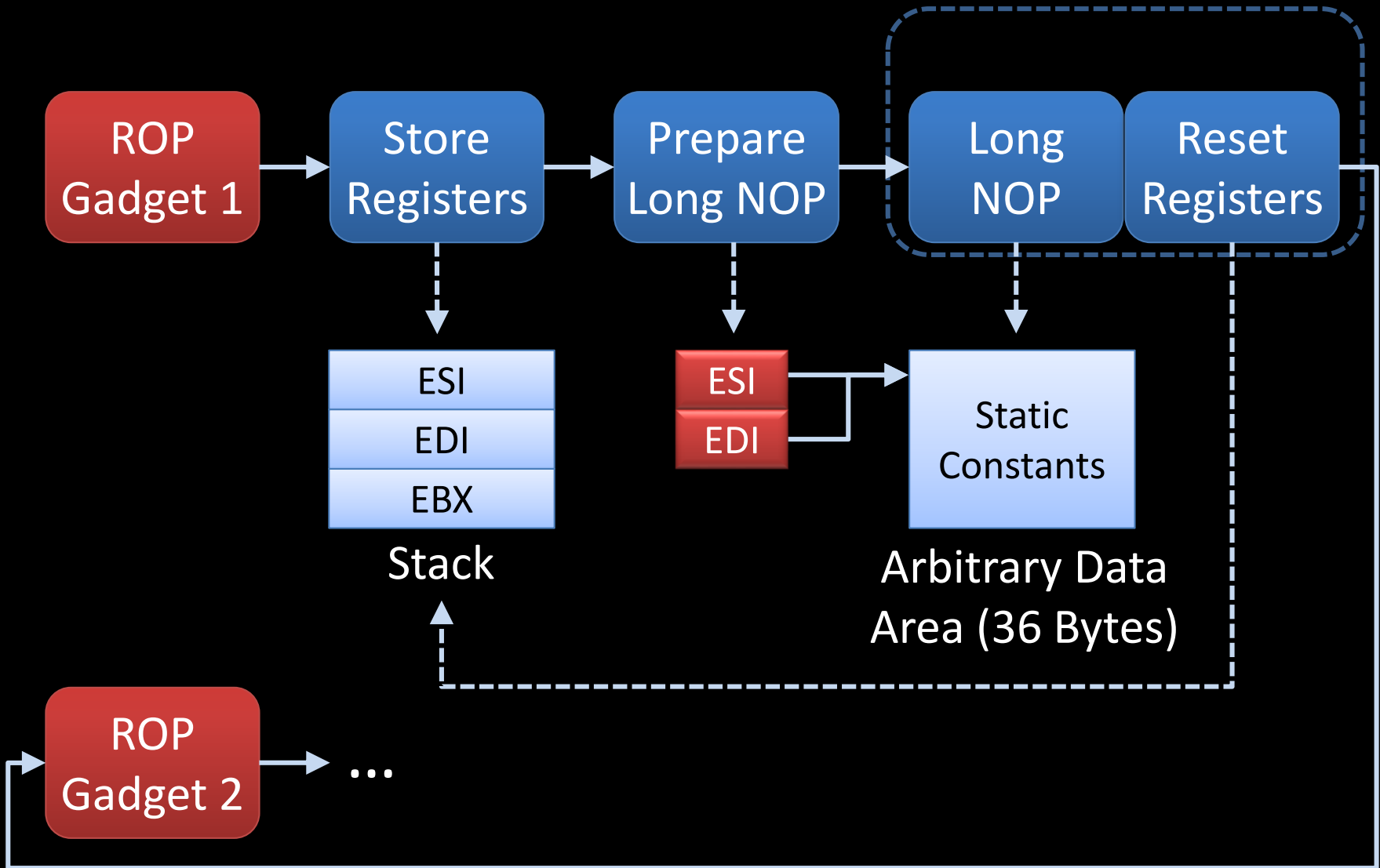

3. Exploit Development

Adobe Reader 9.1
CVE-2010-0188



MPlayer Lite r33064 m3u
Buffer Overflow Exploit



Original exploits
detected by coarse-
grained CFI



Our instrumented
exploits bypass coarse-
grained CFI



Coarse-Grained CFI: Lessons Learned

1. Too many call sites available

→ Restrict returns to their actual caller (shadow stack)

2. Heuristics are ad-hoc and ineffective

→ Adjusted sequence length leads to high false positive

3. Too many indirect jump and call targets

♦ Resolving indirect jumps and calls is non-trivial

→ Compromise: Compiler support

CURRENT RESEARCH

Stack Attacks

CURRENT RESEARCH

What's next?

Hardware-Assisted CFI

HAFIX: Hardware-Assisted Flow Integrity Extension

DAC 2014 and DAC 2015

Lucas Davi, Matthias Hanreich, Debayan Paul, Ahmad-Reza Sadeghi
(TU Darmstadt)

Patrick Koeberl (Intel Labs)

Orlando Arias, Yier Jin, Dean Sullivan (University of Central Florida)

Why Leveraging Hardware for CFI ?

- ◆ Efficiency
 - ◆ Dedicated CFI instructions
- ◆ Security
 - ◆ On-chip memory for CFI data
 - ◆ CFI Context
 - ◆ No unintended sequences
 - ◆ Dynamic code protection

Our Objectives

Backward-Edge and
Forward-Edge CFI

Stateful, Fine-granular

No burden on developer

No code annotations/changes

Security

Hardware protection

On-chip memory for CFI Data

No unintended sequences

High performance

< 3% overhead

Enabling technology

All applications can use CFI
features

Support of multitasking

Compatibility to legacy code

CFI and non-CFI code on same
platform

HAFIX State Model

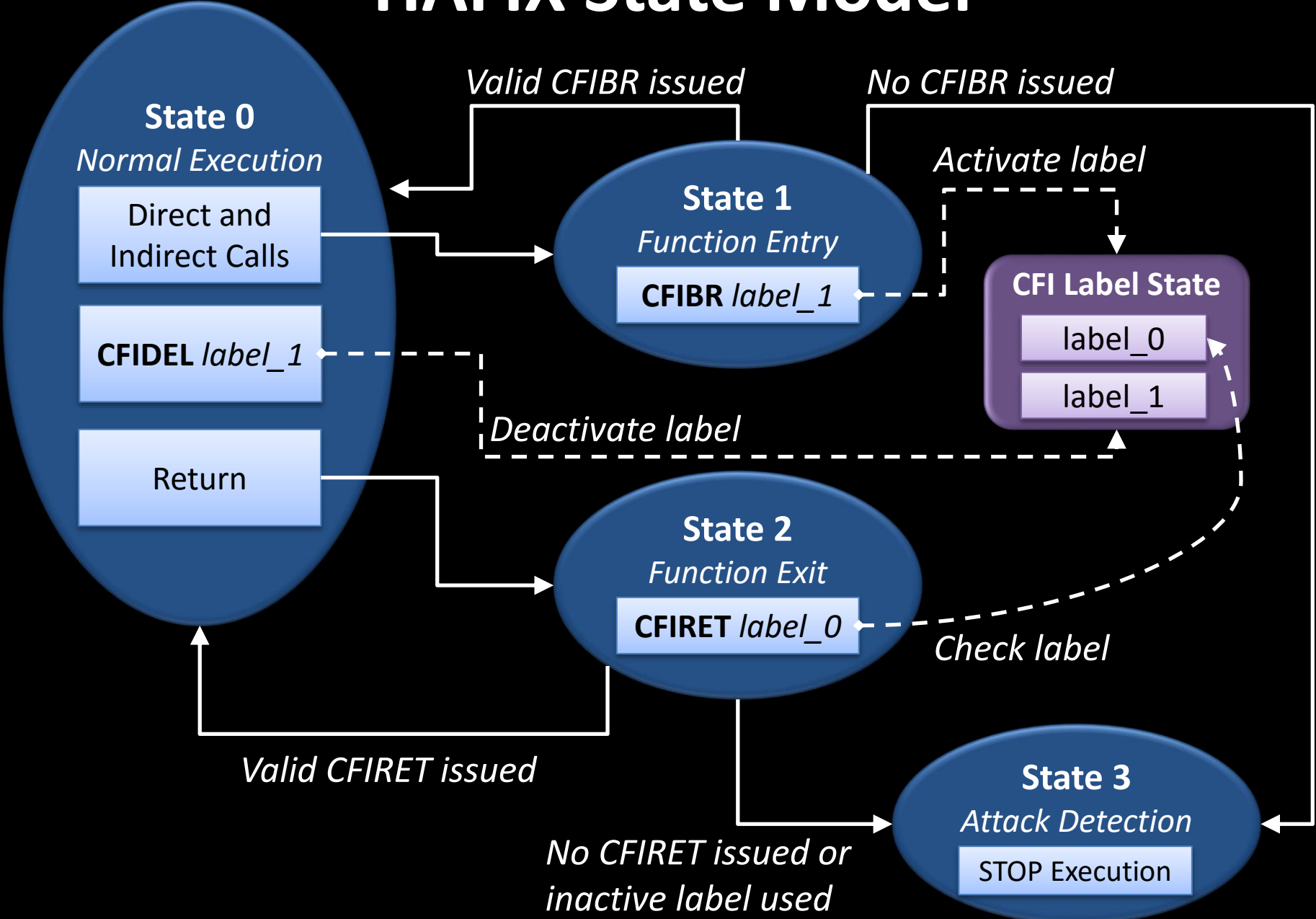

Instrumented Code Example

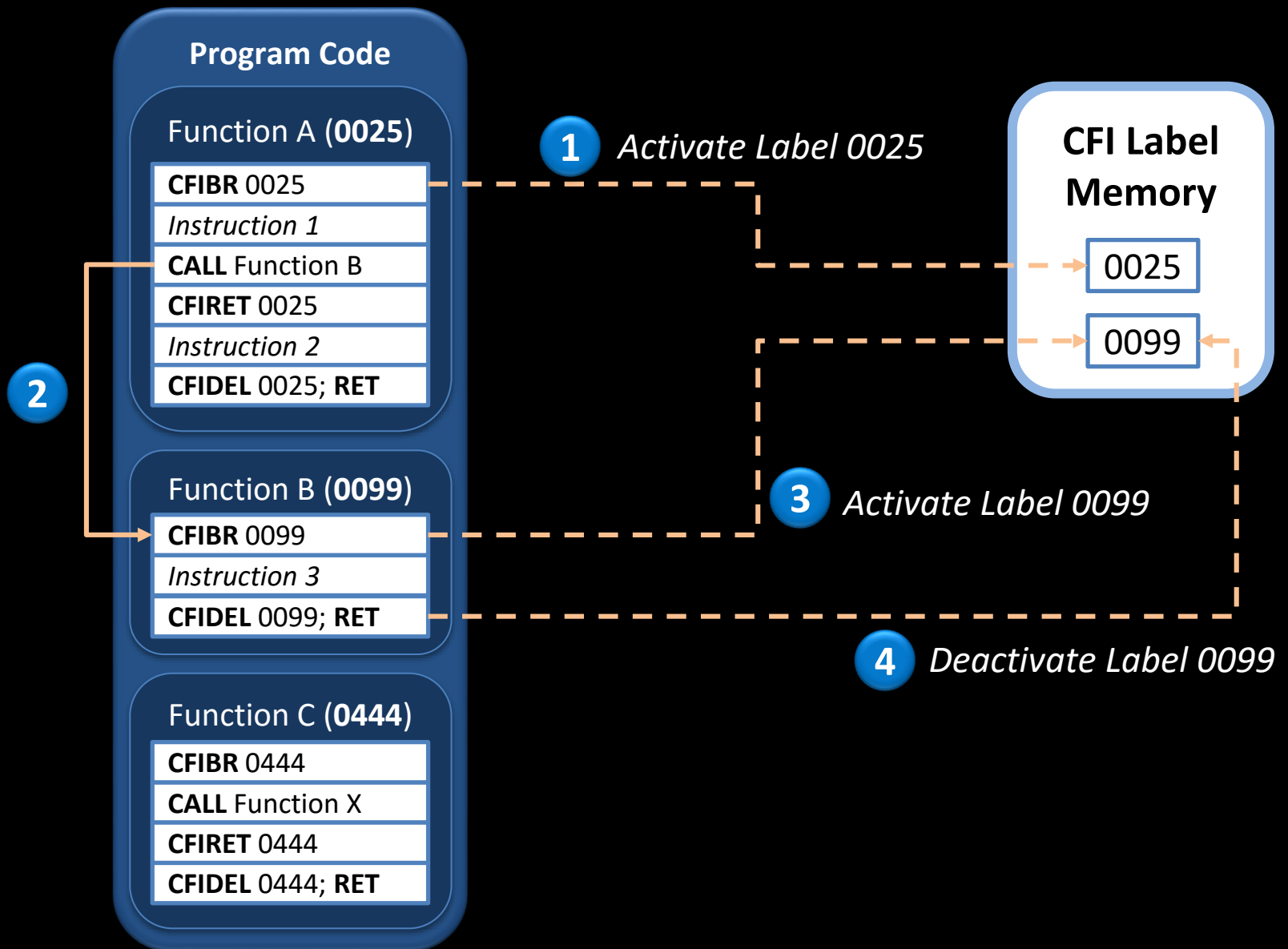

Instrumented Code Example

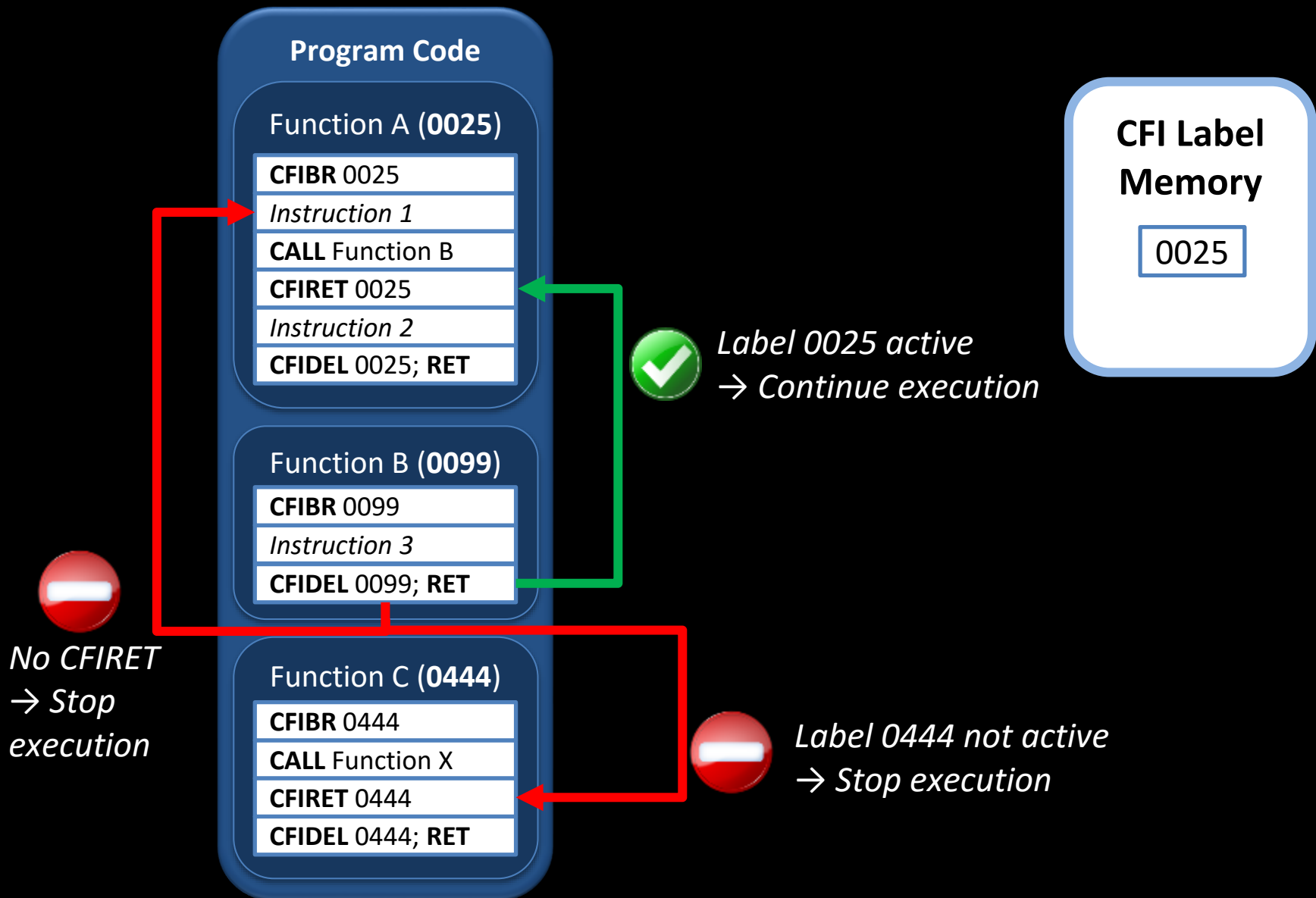

Gadget Space compared to Coarse-Grained CFI for *Static* Binaries

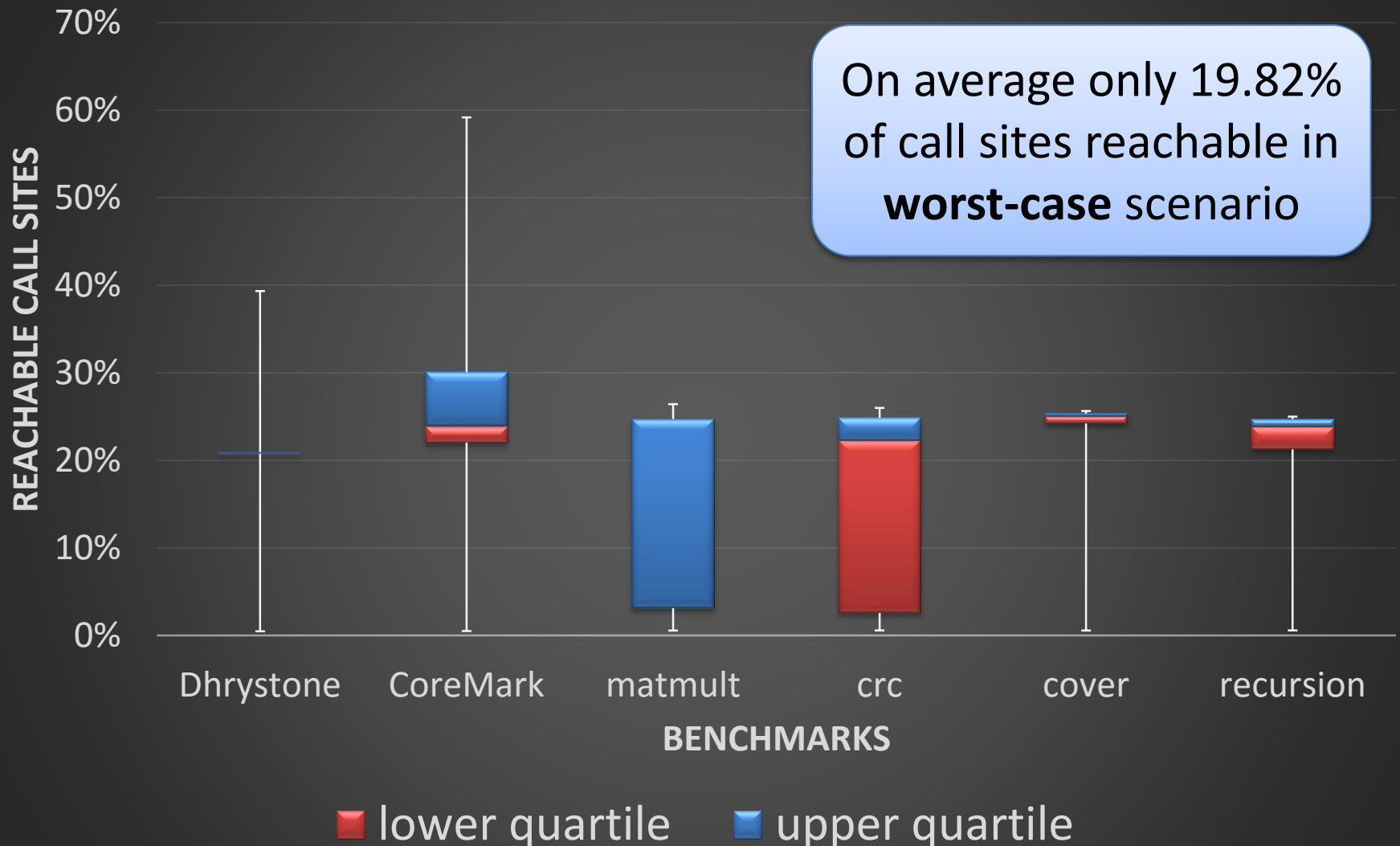

Conclusion

- ◆ Code-reuse attacks are prevalent
 - ◆ Google and Microsoft take these attacks seriously
 - ◆ Many real-world exploits
 - ◆ Existing solutions can be bypassed
- ◆ Good News
 - ◆ Many innovative defense techniques have been proposed
- ◆ Promising new directions
 - ◆ Memory safety based on code-pointer integrity [Kuznetsov et al., OSDI 2014]